



AVTECH ELECTROSYSTEMS LTD.

NANOSECOND WAVEFORM ELECTRONICS
SINCE 1975

P.O. BOX 265
OGDENSBURG, NY
U.S.A. 13669-0265

TEL: 888-670-8729 (USA & Canada) or +1-613-686-6675 (Intl)
FAX: 800-561-1970 (USA & Canada) or +1-613-686-6679 (Intl)

info@avtechpulse.com - <http://www.avtechpulse.com/>

BOX 5120, LCD MERIVALE
OTTAWA, ONTARIO
CANADA K2C 3H4

INSTRUCTIONS

MODEL AV-110J-PS-D

0 to ± 400 V, 50 kHz

VARIABLE-GAIN DUAL-CHANNEL

LINEAR AMPLIFIER

SERIAL NUMBER: _____

WARRANTY

Avtech Electrosystems Ltd. warrants products of its manufacture to be free from defects in material and workmanship under conditions of normal use. If, within one year after delivery to the original owner, and after prepaid return by the original owner, this Avtech product is found to be defective, Avtech shall at its option repair or replace said defective item. This warranty does not apply to units which have been disassembled, modified or subjected to conditions exceeding the applicable specifications or ratings. This warranty is the extent of the obligation assumed by Avtech with respect to this product and no other warranty or guarantee is either expressed or implied.

TECHNICAL SUPPORT

Phone: 888-670-8729 (USA & Canada) or +1-613-686-6675 (International)

Fax: 800-561-1970 (USA & Canada) or +1-613-686-6679 (International)

E-mail: info@avtechpulse.com

World Wide Web: <http://www.avtechpulse.com>

TABLE OF CONTENTS

WARRANTY.....2

TECHNICAL SUPPORT.....2

TABLE OF CONTENTS.....3

INTRODUCTION.....5

HIGH-VOLTAGE PRECAUTIONS.....5

SPECIFICATIONS.....6

REGULATORY NOTES.....7

 FCC PART 18.....7

 EC DECLARATION OF CONFORMITY.....7

 DIRECTIVE 2002/95/EC (RoHS).....8

 DIRECTIVE 2002/96/EC (WEEE).....8

INSTALLATION.....9

 VISUAL CHECK.....9

 POWER RATINGS.....9

 CONNECTION TO THE POWER SUPPLY.....9

 PROTECTION FROM ELECTRIC SHOCK.....10

 ENVIRONMENTAL CONDITIONS.....11

FUSES.....12

 AC FUSE REPLACEMENT.....12

 DC FUSE REPLACEMENT.....13

 FUSE RATINGS.....13

FRONT PANEL CONTROLS.....14

REAR PANEL CONTROLS.....16

GENERAL INFORMATION.....17

 BASIC CONTROL.....17

 CABLE LENGTHS.....17

OPERATIONAL CHECK.....18

MECHANICAL INFORMATION.....20

 TOP COVER REMOVAL.....20

 RACK MOUNTING.....20

 ELECTROMAGNETIC INTERFERENCE.....20

MAINTENANCE.....21

 REGULAR MAINTENANCE.....21

 CLEANING.....21

WIRING DIAGRAMS.....	22
WIRING OF AC POWER, STYLE 1.....	22
WIRING OF AC POWER, STYLE 2.....	23
PCB 158N - LOW VOLTAGE POWER SUPPLY, 1/3.....	24
PCB 158N - LOW VOLTAGE POWER SUPPLY, 2/3.....	25
PCB 158N - LOW VOLTAGE POWER SUPPLY, 3/3.....	26
PCB 170B - HIGH VOLTAGE DC POWER SUPPLY.....	27
MAIN WIRING.....	28
PERFORMANCE CHECK SHEET.....	29

Manual Reference: /fileserver/officefiles/instructword/av-110/AV-110J-PS-D,ed1.odt.

Last modified January 27, 2010.

Copyright © 2010 Avtech Electrosystems Ltd, All Rights Reserved.

INTRODUCTION

The AV-110J-PS-D is a variable-gain dual-channel linear amplifier. The input range is 0 to $\pm 2V$, and the output range is 0 to $\pm 400V$. The outputs can drive load impedances of 10 k Ω and higher. The amplifier bandwidth is 50 kHz.

The gain for each of the two independent channels may be adjusted from +1 to +200.

Units with the -INV or -SCHA options also have an inverting mode, allowing the gain to be adjusted between -1 and -200.

HIGH-VOLTAGE PRECAUTIONS

 **CAUTION:** This instrument provides output voltages as high as ± 400 Volts, so extreme caution must be employed when using this instrument. The instrument should only be used by individuals who are thoroughly skilled in high voltage laboratory techniques. The following precaution should always be observed:

1. Keep exposed high-voltage wiring to an absolute minimum.
2. Wherever possible, use shielded connectors and cabling.
3. Connect and disconnect loads and cables only when the amplifier is turned off.
4. Keep in mind that all cables, connectors, oscilloscope probes, and loads must have an appropriate voltage rating.
5. Do not attempt any repairs on the instrument, beyond the fuse replacement procedures described in this manual. Contact Avtech technical support (see page 2 for contact information) if the instrument requires servicing.

SPECIFICATIONS

Model:	AV-110J-PS-D
Output amplitude:	0 to ± 400 V
Maximum current:	40 mA
Load impedance:	≥ 10 k Ω
Output resistance ¹ :	$\approx 0\Omega$
Bandwidth (f _{-3dB}):	50 kHz
Rise time (20%-80%, for maximum output):	3.5 us
Output power (maximum)	16 W
Voltage gain ² :	$\times 1$ to $\times 200$
Gain polarity:	Standard: Non-inverting (+) Optional ⁵ : Switchable between Non-inverting (+) and Inverting (-) modes
Input range ² :	0 to ± 2 Volts (1 k Ω input impedance)
Dual channel:	Yes (-D Option ³)
Regular DC offset option ^{2,4,7} :	± 100 V
Extended DC offset option ^{2,6,7} :	± 400 V
Connectors:	In, Out: BNC
Dimensions:	100 mm x 430 mm x 375 mm (3.9" x 17" x 14.8")
Power requirement:	100-240 Volts, 50-60 Hz

- 1) "Output resistance" is the internal resistance in series with output. Non-zero output impedances (R_{OUT}) will reduce the maximum output amplitude slightly when operating into low load impedances. That is, $V_{OUT} = V_{SET} \times R_{LOAD} / (R_{LOAD} + R_{OUT})$, where V_{SET} is the set amplitude and R_{LOAD} is the load resistance.
- 2) These parameters can easily be adapted to meet special requirements. Contact Avtech (info@avtechpulse.com) with your special application!
- 3) To specify the two channel option add the suffix -D to the model number.
- 4) To specify the regular DC offset option, add the suffix -OS to the model number.
- 5) Add the suffix -INV to specify the switchable gain polarity feature.
- 6) To specify the extended DC offset option, add the suffix -OS to the model number.
- 7) The sum of the amplitude and the offset must remain within the rated output amplitude range – i.e., this option does not change the minimum or maximum obtainable output voltage.

REGULATORY NOTES

FCC PART 18

This device complies with part 18 of the FCC rules for non-consumer industrial, scientific and medical (ISM) equipment.

This instrument is enclosed in a rugged metal chassis and uses a filtered power entry module (where applicable). The main output signal is provided on a shielded connector that is intended to be used with shielded coaxial cabling and a shielded load. Under these conditions, the interference potential of this instrument is low.

If interference is observed, check that appropriate well-shielded cabling is used on the output connectors. Contact Avtech (info@avtechpulse.com) for advice if you are unsure of the most appropriate cabling. Also, check that your load is adequately shielded. It may be necessary to enclose the load in a metal enclosure.

If any of the connectors on the instrument are unused, they should be covered with shielded metal "dust caps" to reduce the interference potential.

This instrument does not normally require regular maintenance to minimize interference potential. However, if loose hardware or connectors are noted, they should be tightened. Contact Avtech (info@avtechpulse.com) if you require assistance.

EC DECLARATION OF CONFORMITY



We Avtech Electrosystems Ltd.
 P.O. Box 5120, LCD Merivale
 Ottawa, Ontario
 Canada K2C 3H4

declare that this pulse generator meets the intent of Directive 89/336/EEC for Electromagnetic Compatibility. Compliance pertains to the following specifications as listed in the official Journal of the European Communities:

EN 50081-1 Emission

EN 50082-1 Immunity

and that this pulse generator meets the intent of the Low Voltage Directive 72/23/EEC as amended by 93/68/EEC. Compliance pertains to the following specifications as listed in the official Journal of the European Communities:

EN 61010-1:2001 Safety requirements for electrical equipment for measurement, control, and laboratory use

DIRECTIVE 2002/95/EC (RoHS)

This instrument is exempt from Directive 2002/95/EC of the European Parliament and of the Council of 27 January 2003 on the Restriction of the use of certain Hazardous Substances (RoHS) in electrical and electronic equipment. Specifically, Avtech instruments are considered "Monitoring and control instruments" (Category 9) as defined in Annex 1A of Directive 2002/96/EC. The Directive 2002/95/EC only applies to Directive 2002/96/EC categories 1-7 and 10, as stated in the "Article 2 - Scope" section of Directive 2002/95/EC.

DIRECTIVE 2002/96/EC (WEEE)

European customers who have purchased this equipment directly from Avtech will have completed a "WEEE Responsibility Agreement" form, accepting responsibility for WEEE compliance (as mandated in Directive 2002/96/EC of the European Union and local laws) on behalf of the customer, as provided for under Article 9 of Directive 2002/96/EC.

Customers who have purchased Avtech equipment through local representatives should consult with the representative to determine who has responsibility for WEEE compliance. Normally, such responsibilities will lie with the representative, unless other arrangements (under Article 9) have been made.

Requirements for WEEE compliance may include registration of products with local governments, reporting of recycling activities to local governments, and financing of recycling activities.

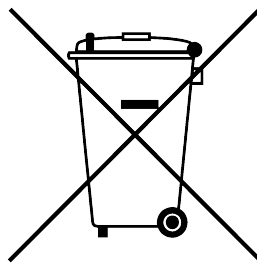

INSTALLATION

VISUAL CHECK

After unpacking the instrument, examine to ensure that it has not been damaged in shipment. Visually inspect all connectors, knobs, and handles. Confirm that a power cord is with the instrument. If the instrument has been damaged, file a claim immediately with the company that transported the instrument.

POWER RATINGS

This instrument is intended to operate from 100 - 240 V, 50 - 60 Hz.

The maximum power consumption is 125 Watts. Please see the “FUSES” section for information about the appropriate AC and DC fuses.

This instrument is an “Installation Category II” instrument, intended for operation from a normal single-phase supply.

CONNECTION TO THE POWER SUPPLY

An IEC-320 three-pronged recessed male socket is provided on the back panel for AC power connection to the instrument. One end of the detachable power cord that is supplied with the instrument plugs into this socket. The other end of the detachable power cord plugs into the local mains supply. Use only the cable supplied with the instrument. The mains supply must be earthed, and the cord used to connect the instrument to the mains supply must provide an earth connection. (The supplied cord does this.)

 Warning: Failure to use a grounded outlet may result in injury or death due to electric shock. This product uses a power cord with a ground connection. It must be connected to a properly grounded outlet. The instrument chassis is connected to the ground wire in the power cord.

The table below describes the power cord that is normally supplied with this instrument, depending on the destination region:

Destination Region	Description	Option	Manufacturer	Part Number
United Kingdom, Hong Kong, Singapore, Malaysia	BS 1363, 230V, 50 Hz	-AC00	Qualtek ¹	370001-E01
Australia, New Zealand	AS 3112:2000, 230-240V, 50 Hz	-AC01	Qualtek ¹	374003-A01
Continental Europe, Korea, Indonesia, Russia	European CEE 7/7 "Schuko" 230V, 50 Hz	-AC02	Qualtek ¹	364002-D01
North America, Taiwan	NEMA 5-15, 120V, 60 Hz	-AC03	Qualtek ¹	312007-01
Switzerland	SEV 1011, 230V, 50 Hz	-AC06	Qualtek ¹	378001-E01
South Africa, India	SABS 164-1, 220-250V, 50 Hz	-AC17	Volex ²	2131H 10 C3
Japan	JIS 8303, 100V, 50-60 Hz	-AC18	Qualtek ¹	397002-01
Israel	SI 32, 220V, 50 Hz	-AC19	Qualtek ¹	398001-01
China	GB 1002-1, 220V, 50 Hz	-AC22	Volex ²	2137H 10 C3

PROTECTION FROM ELECTRIC SHOCK

 Operators of this instrument must be protected from electric shock at all times. The owner must ensure that operators are prevented access and/or are insulated from every connection point. In some cases, connections must be exposed to potential human contact. Operators must be trained to protect themselves from the risk of electric shock. This instrument is intended for use by qualified personnel who recognize shock hazards and are familiar with safety precautions required to avoid possibly injury. In particular, operators should:

1. Keep exposed high-voltage wiring to an absolute minimum.
2. Wherever possible, use shielded connectors and cabling.
3. Connect and disconnect loads and cables only when the instrument is turned off.
4. Keep in mind that all cables, connectors, oscilloscope probes, and loads must have an appropriate voltage rating.
5. Do not attempt any repairs on the instrument, beyond the fuse replacement procedures described in this manual. Contact Avtech technical support (see page 2 for contact information) if the instrument requires servicing. Service is to be performed solely by qualified service personnel.

ENVIRONMENTAL CONDITIONS

This instrument is intended for use under the following conditions:

1. indoor use;
2. altitude up to 2 000 m;
3. temperature 5 °C to 40 °C;
4. maximum relative humidity 80 % for temperatures up to 31 °C decreasing linearly to 50 % relative humidity at 40 °C;
5. Mains supply voltage fluctuations up to ± 10 % of the nominal voltage;
6. no pollution or only dry, non-conductive pollution.

FUSES

This instrument contains four fuses. All are accessible from the rear-panel. Two protect the AC prime power input, and two protect the internal DC power supplies. The locations of the fuses on the rear panel are shown in the figure below:

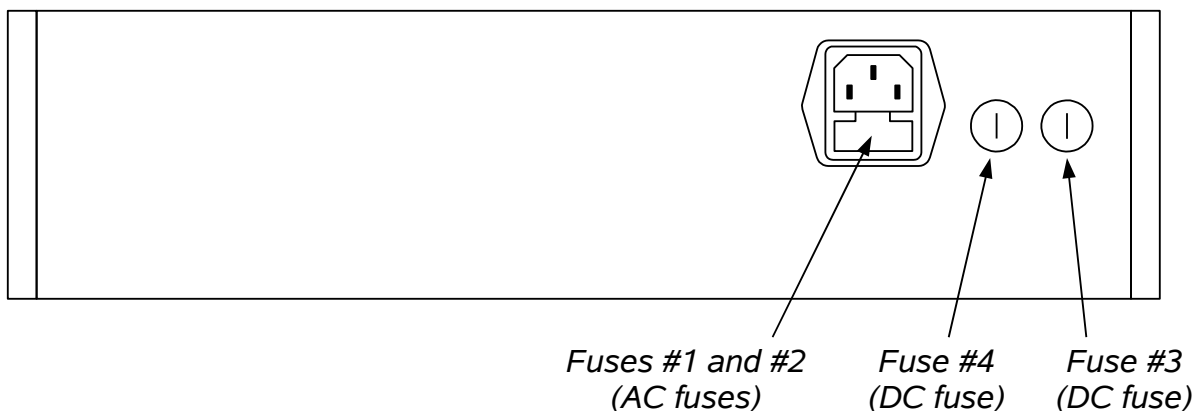

AC FUSE REPLACEMENT

To physically access the AC fuses, the power cord must be detached from the rear panel of the instrument. The fuse drawer may then be extracted using a small flat-head screwdriver, as shown below:

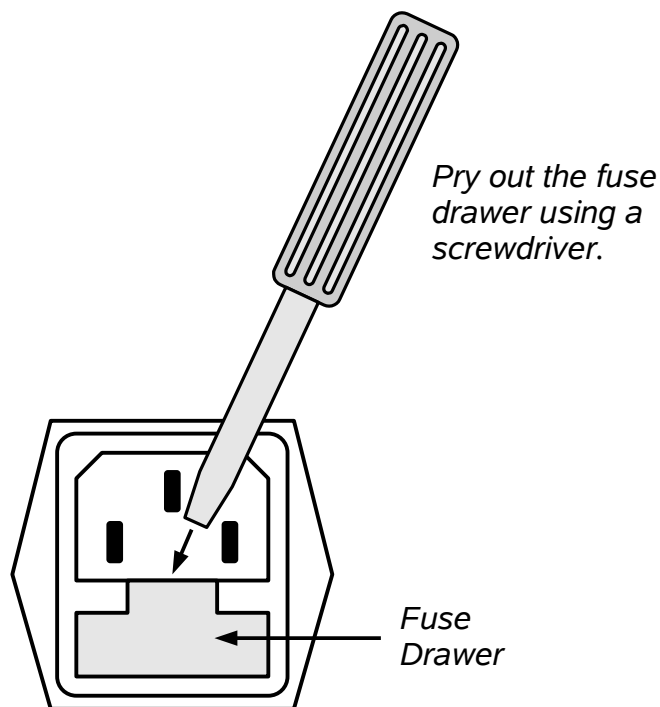

DC FUSE REPLACEMENT

The DC fuses may be replaced by inserting the tip of a flat-head screwdriver into the fuse holder slot, and rotating the slot counter-clockwise. The fuse and its carrier will then pop out.

FUSE RATINGS

The following table lists the required fuses:

Fuses	Nominal Mains Voltage	Rating	Case Size	Recommended Replacement Part	
				Littelfuse Part Number	Digi-Key Stock Number
#1, #2 (AC)	115 V	1.0A, 250V, Time-Delay	5×20 mm	0218001.HXP	F2419-ND
	230 V	0.5A, 250V, Time-Delay	5×20 mm	0218.500HXP	F2416-ND
#3 (DC)	N/A	4.0A, 250V, Time-Delay	5×20 mm	0218004.HXP	F2421-ND
#4 (DC)	N/A	4.0A, 250V, Time-Delay	5×20 mm	0218004.HXP	F2421-ND

The recommended fuse manufacturer is Littelfuse (<http://www.littelfuse.com>).

Replacement fuses may be easily obtained from Digi-Key (<http://www.digikey.com>) and other distributors.

FRONT PANEL CONTROLS

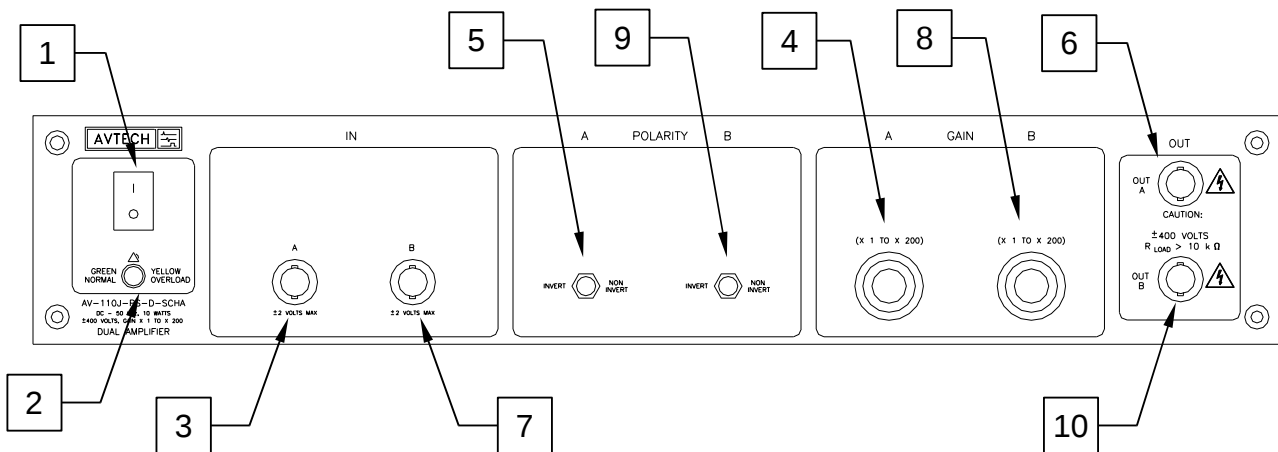

1. **POWER Switch.** This is the main power switch. When turning the instrument on, there may be a delay of several seconds before the instrument appears to respond.
2. **OVERLOAD Indicator.** When the instrument is powered, this indicator is normally green, indicating normal operation. If this indicator is yellow, an internal automatic overload protection circuit has been tripped. If the unit is overloaded (by operating at an exceedingly high duty cycle or by operating into a very low impedance), the protective circuit will disable the output of the instrument and turn the indicator light yellow. The light will stay yellow (i.e. output disabled) for about 5 seconds after which the instrument will attempt to re-enable the output (i.e. light green) for about 1 second. If the overload condition persists, the output will be disabled again (i.e. light yellow) for another 5 seconds. If the overload condition has been removed, the instrument will resume normal operation.

This overload indicator is only likely to come on in two situations:

- Briefly at startup. This is not a cause for concern.
 - When the load impedance is too low ($< 10 \text{ k}\Omega$). In this case, turn off the instrument and connect the proper load.
3. **IN A Connector.** The input signal for the Channel A amplifier is applied to this BNC connector. The input must not exceed $\pm 2\text{V}$. The input impedance is approximately $1 \text{ k}\Omega$. Depending on the length of cable attached to this input, and the source driving it, it may be desirable to add a coaxial 50 Ohm terminator to this input to provide a proper transmission line termination. The Pasternack (www.pasternack.com) PE6008-50 BNC feed-thru 50 Ohm terminator is suggested for this purpose.
 4. **GAIN A Dial.** This ten-turn dial is used to vary the gain of the Channel A amplifier between < 1 and > 200 .
 5. **GAIN POLARITY A Switch.** (Optional. Requires -INV or -SCHA option.) Standard units operate with non-inverting gain (+). Units with this switch also the gain to be

switched between non-inverting (+) or inverting (-) modes.

6. OUT A Connector. This BNC connector provides the main output of the Channel A amplifier. The output is an amplified version of the input on (3). The gain (V_{OUT}/V_{IN}) is controlled by (4) and (5).

 Caution: Voltages as high as $\pm 400V$ may be present on the center conductor of this output connector. Avoid touching this conductor. Connect to this connector using standard coaxial cable, to ensure that the center conductor is not exposed.

7. IN B Connector. The input signal for the Channel B amplifier is applied to this BNC connector. The input must not exceed $\pm 2V$. The input impedance is approximately $1\text{ k}\Omega$. Depending on the length of cable attached to this input, and the source driving it, it may be desirable to add a coaxial 50 Ohm terminator to this input to provide a proper transmission line termination. The Pasternack (www.pasternack.com) PE6008-50 BNC feed-thru 50 Ohm terminator is suggested for this purpose.
8. GAIN B Dial. This ten-turn dial is used to vary the gain of the Channel B amplifier between < 1 and > 200 .
9. GAIN POLARITY B Switch. (Optional. Requires -INV or -SCHA option.) Standard units operate with non-inverting gain (+). Units with this switch also the gain to be switched between non-inverting (+) or inverting (-) modes.
10. OUT B Connector. This BNC connector provides the main output of the Channel B amplifier. The output is an amplified version of the input on (7). The gain (V_{OUT}/V_{IN}) is controlled by (8) and (9).

 Caution: Voltages as high as $\pm 400V$ may be present on the center conductor of this output connector. Avoid touching this conductor. Connect to this connector using standard coaxial cable, to ensure that the center conductor is not exposed.

Units with the -OS or -XOS options will have additional controls (not shown) to control the DC offset feature:

11. OFFSET A Dial. (Optional. Requires -OS or -XOS option.) This ten-turn dial is used to vary the DC offset of the OUT A output, in the range of $-100V$ to $+100V$ (for -OS units) or $-400V$ to $+400V$ (for -XOS units). The switch below this dial can be used to enable/disable this feature.
12. OFFSET B Dial. (Optional. Requires -OS or -XOS option.) This ten-turn dial is used to vary the DC offset of the OUT B output, in the range of $-100V$ to $+100V$ (for -OS units) or $-400V$ to $+400V$ (for -XOS units). The switch below this dial can be used to enable/disable this feature.

REAR PANEL CONTROLS

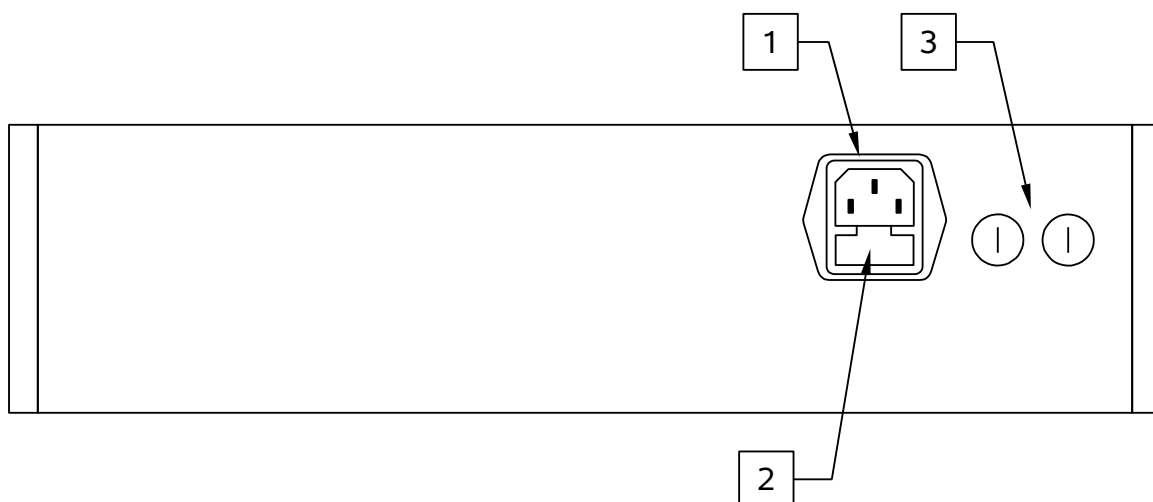

1. AC POWER INPUT. An IEC-320 C14 three-pronged recessed male socket is provided on the back panel for AC power connection to the instrument. One end of the detachable power cord that is supplied with the instrument plugs into this socket.
2. AC FUSE DRAWER. The two fuses that protect the AC input are located in this drawer. Please see the “FUSES” section of this manual for more information.
3. DC FUSES. These two fuses protect the internal DC power supplies. Please see the “FUSES” sections of this manual for more information.

GENERAL INFORMATION

BASIC CONTROL

The AV-110J-PS-D is a DC-50 kHz variable-gain linear amplifier. The gain of each of the two channels (designated "A" and "B") is variable from +1 to +200, and is adjusted by rotating the "Gain" associated control.

Units with the -INV or -SCHA options will also have a switch that can be used to enable an inverting mode, in which case the gain is variable from -1 to -200.

The required voltage input signals are applied at the "IN" connectors.

This operation is illustrated below:

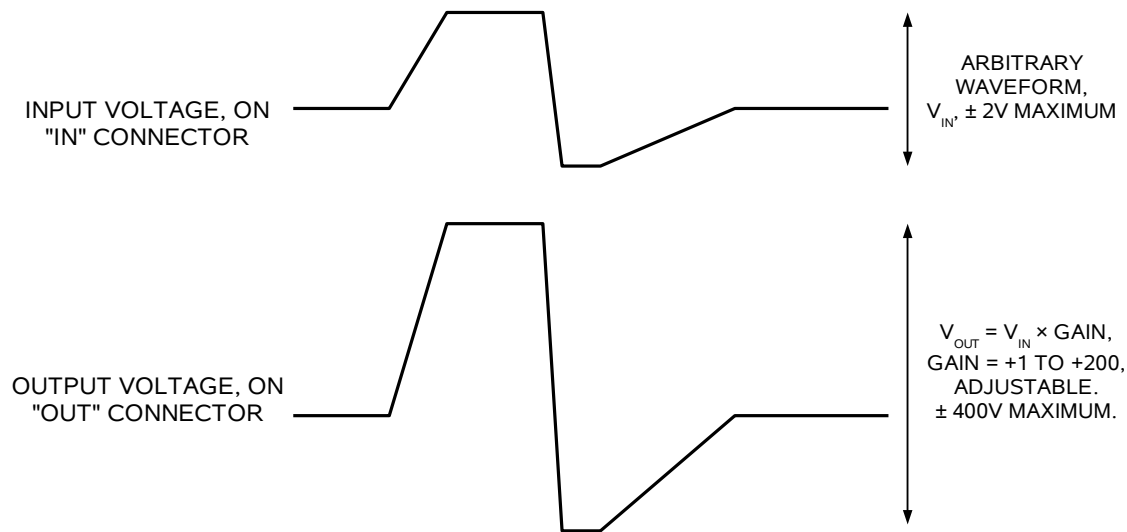

If the instrument has the -OS option, a DC offset in the range of of -100V to +100V (for -OS units) or -400V to +400V (for -XOS units) may be added to each output. The total output voltage (amplified signal + DC offset) must remain within the range of -400V to +400V.

CABLE LENGTHS

The length of cable used to connect the load to the output of the function generator should be less than 3 feet (1 meter), and ideally less than 18 inches (0.5 meters). At longer lengths, the transmission line reflections caused by the cabling and the cable's capacitance will distort the output signal and degrade the rise and fall times, particularly if the signals with fast rise times are used.

The capacitance associated with any length of coaxial cabling will degrade the rise and fall times of fast signals.

OPERATIONAL CHECK

This section describes a sequence to confirm the basic operation of the instrument. It should be performed after receiving the instrument. It is a useful learning exercise as well.

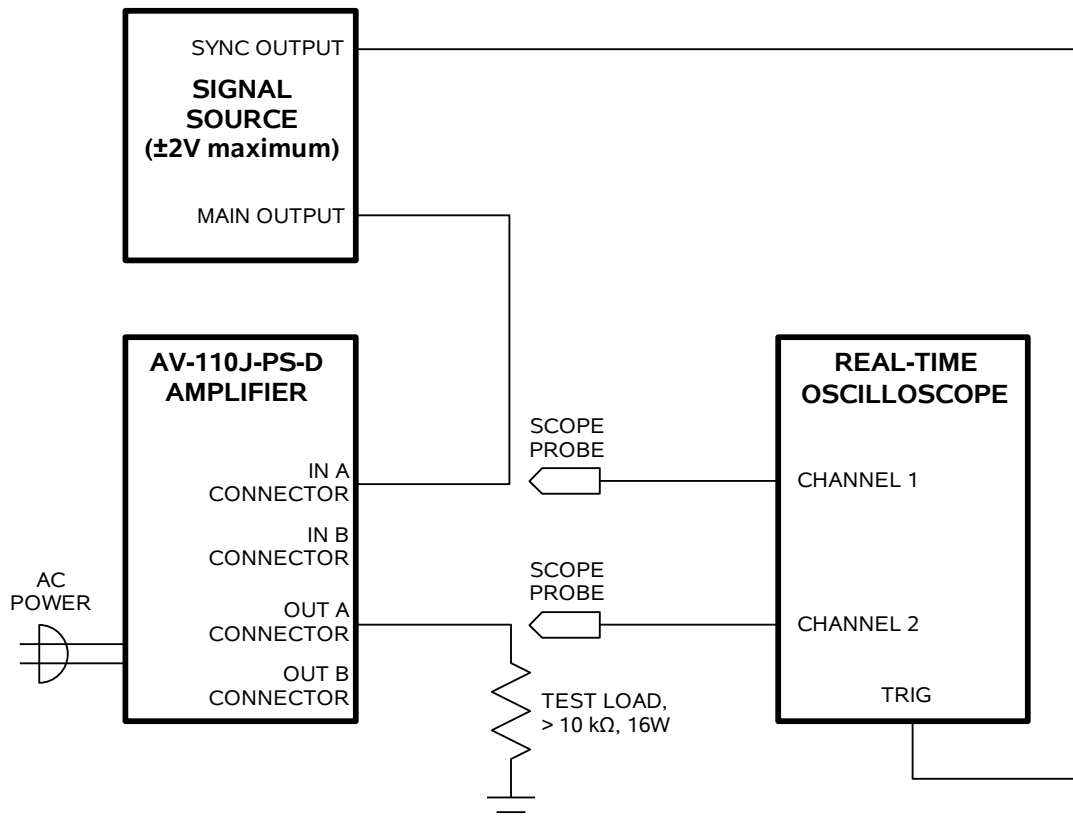

Basic Test Arrangement

- 1) Connect a 10 k Ω , 16W non-inductive test load between the OUT A connector and ground. A higher resistance may also be used, in which case the power rating may be reduced. If cabling is used, keep it less than 3 feet / 1 meter in length. Confirm that the oscilloscope probe and the test load are rated for 400 Volt operation.
- 2) Set the signal generator to produce a $\pm 2V$, 10 kHz waveform. (The input impedance of the AV-110J-PS-D is 1 k Ω). Connect a cable from the SYNC connector of the signal generator to the TRIG input of an oscilloscope. Set the oscilloscope to trigger externally. Connect the main output of the signal generator to the input of the amplifier.
- 3) Connect one oscilloscope probe (channel 1) to the output of the signal generator. Set the Channel 1 vertical scale to 1 V/div.
- 4) Connect one oscilloscope probe (channel 2) to the 10 k Ω load. On the oscilloscope, set the channel 1 vertical scale to 100 V/div, and the horizontal scale to 100 us/div.

- 5) Set the gain control to minimum (0.0). Turn on the amplifier and the signal generator.
- 6) Rotate the gain control to its maximum setting. The Channel 2 waveform should increase to $\pm 400\text{V}$, and have a shape similar to that of the Channel 1 waveform.
- 7) Repeat the previous steps using the IN B and OUT B connectors.
- 8) This completes the operational check.

MECHANICAL INFORMATION

TOP COVER REMOVAL

If necessary, the interior of the instrument may be accessed by removing the four Phillips screws on the top panel. With the four screws removed, the top cover may be slid back (and off).

 Always disconnect the power cord and allow the instrument to sit unpowered for 10 minutes before opening the instrument. This will allow any internal stored charge to discharge.

There are no user-adjustable internal circuits. For repairs other than fuse replacement, please contact Avtech (info@avtechpulse.com) to arrange for the instrument to be returned to the factory for repair. Service is to be performed solely by qualified service personnel.

 Caution: High voltages are present inside the instrument during normal operation. Do not operate the instrument with the cover removed.

RACK MOUNTING

A rack mounting kit is available. The -R5 rack mount kit may be installed after first removing the one Phillips screw on the side panel adjacent to the front handle.

ELECTROMAGNETIC INTERFERENCE

To prevent electromagnetic interference with other equipment, all used outputs should be connected to shielded loads using shielded coaxial cables. Unused outputs should be terminated with shielded coaxial terminators or with shielded coaxial dust caps, to prevent unintentional electromagnetic radiation. All cords and cables should be less than 3m in length.

MAINTENANCE

REGULAR MAINTENANCE

This instrument does not require any regular maintenance.

On occasion, one or more of the four rear-panel fuses may require replacement. All fuses can be accessed from the rear panel. See the “FUSES” section for details.

CLEANING

If desired, the interior of the instrument may be cleaned using compressed air to dislodge any accumulated dust. (See the “TOP COVER REMOVAL” section for instructions on accessing the interior.) No other cleaning is recommended.

WIRING DIAGRAMS

WIRING OF AC POWER, STYLE 1

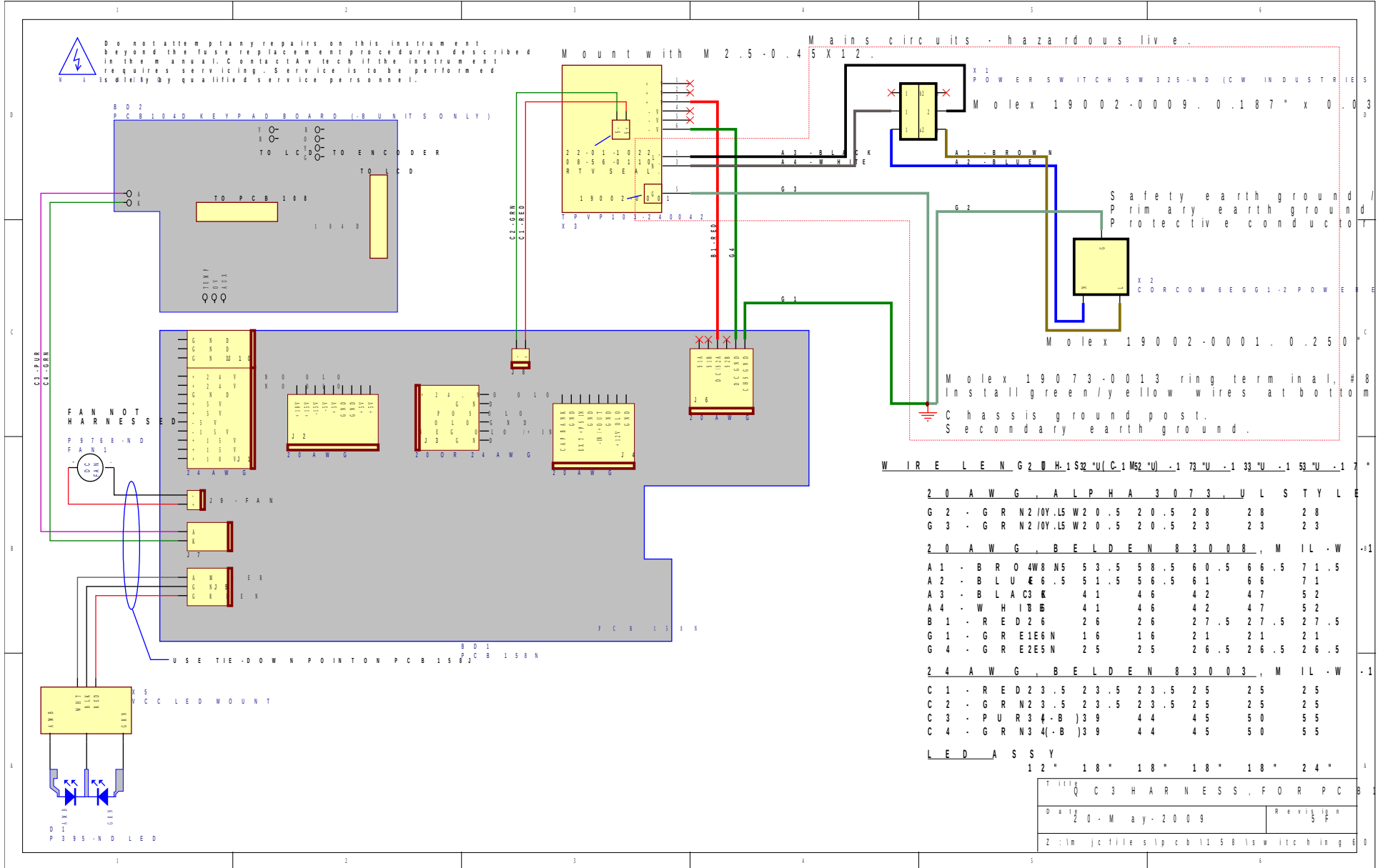

WIRING OF AC POWER, STYLE 2

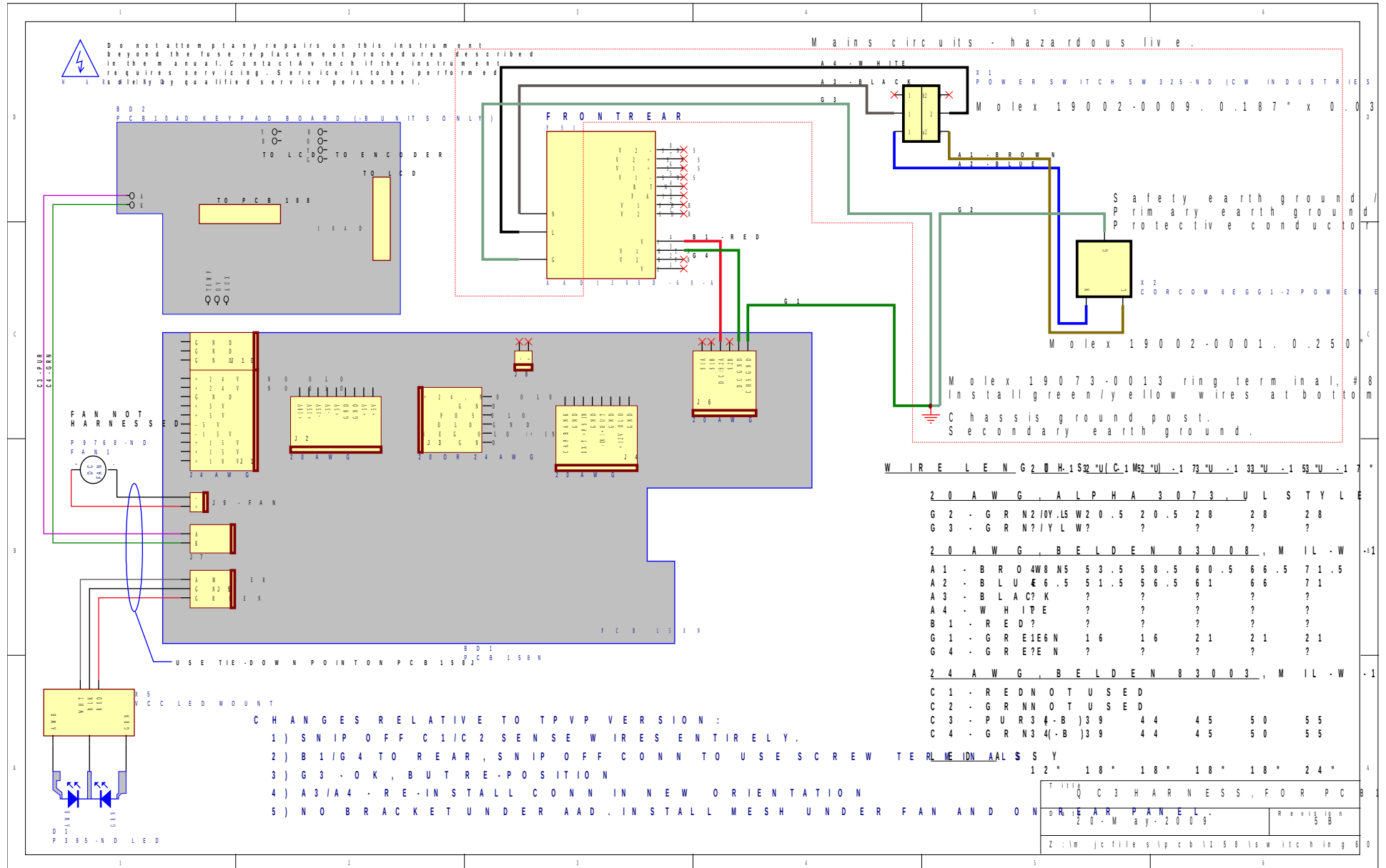

PCB 158N - LOW VOLTAGE POWER SUPPLY, 1/3

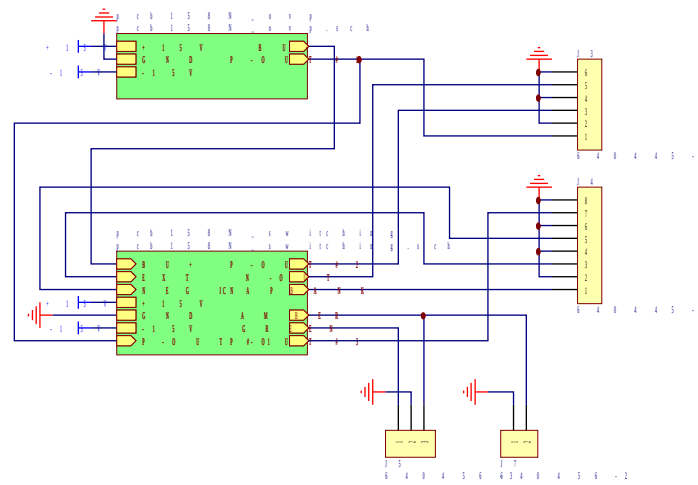

T i t l e		L O W V O L T A G E D C / D C P O
D a t e		1 2 - D e c - 2 0 0 8
R e v i s i o n		
Z : I m j c i t i e s i p c b 1 1 5 8 i s w i t c h i n g 0		

PCB 158N - LOW VOLTAGE POWER SUPPLY, 2/3

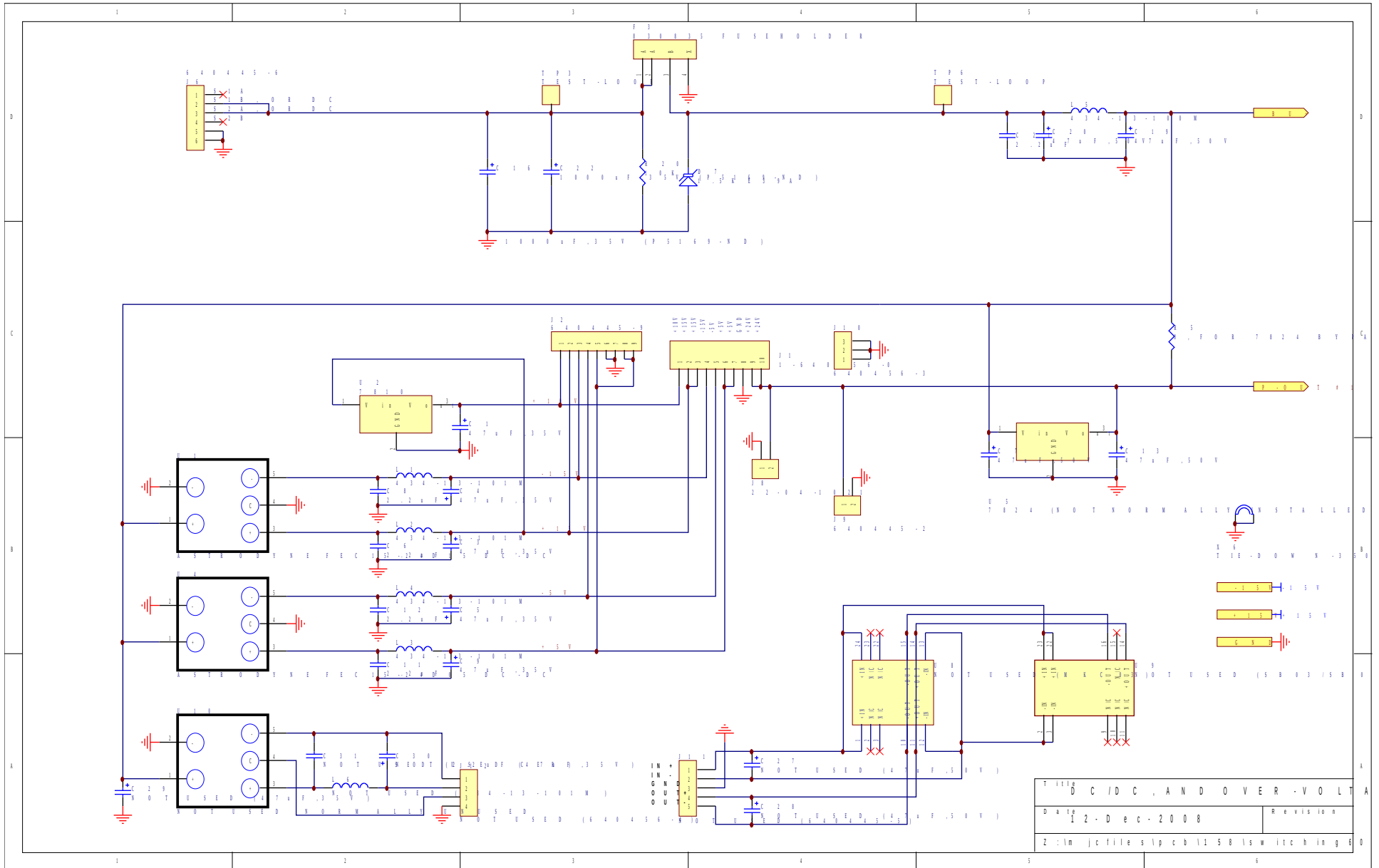

PCB 158N - LOW VOLTAGE POWER SUPPLY, 3/3

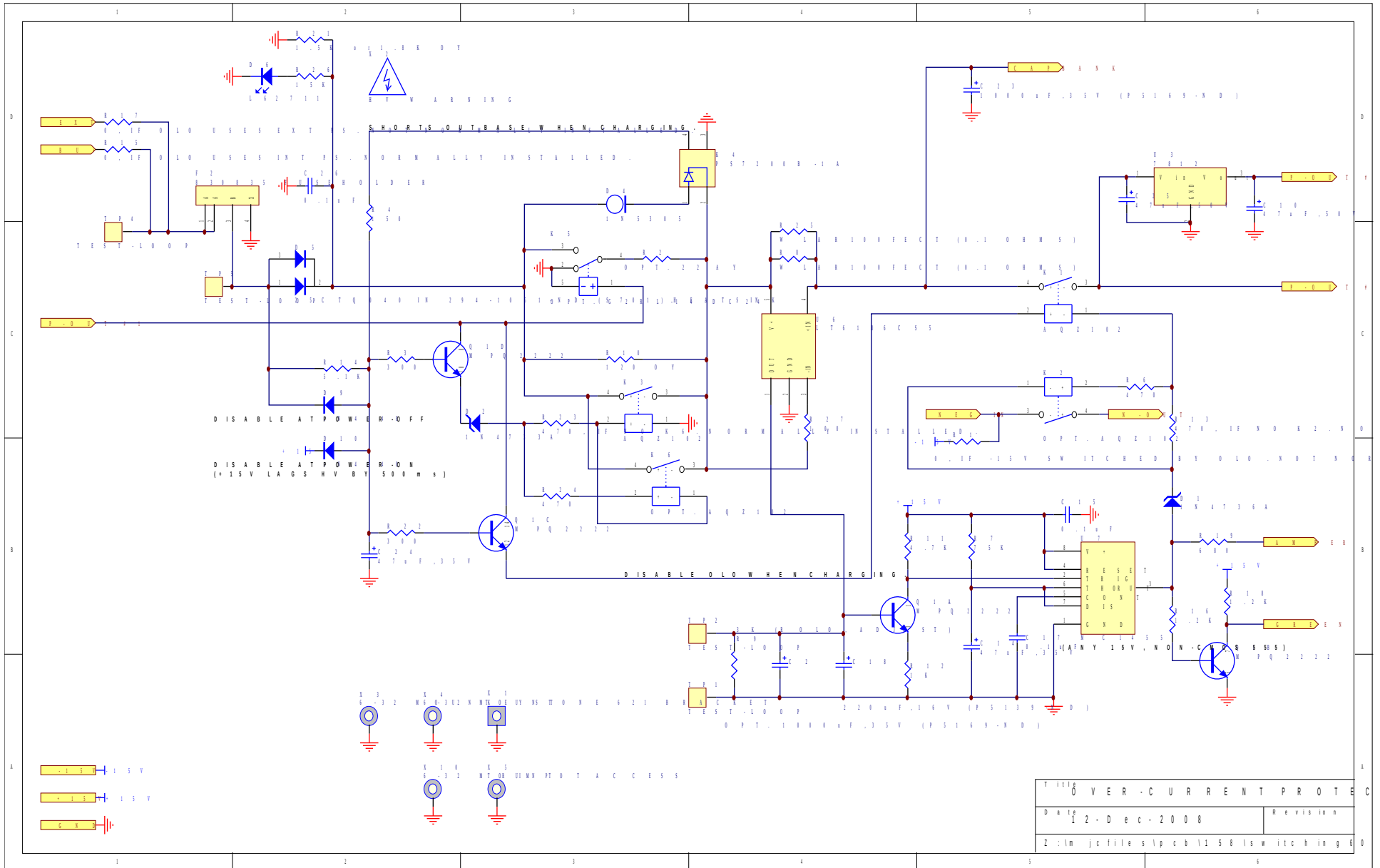

PCB 170B - HIGH VOLTAGE DC POWER SUPPLY

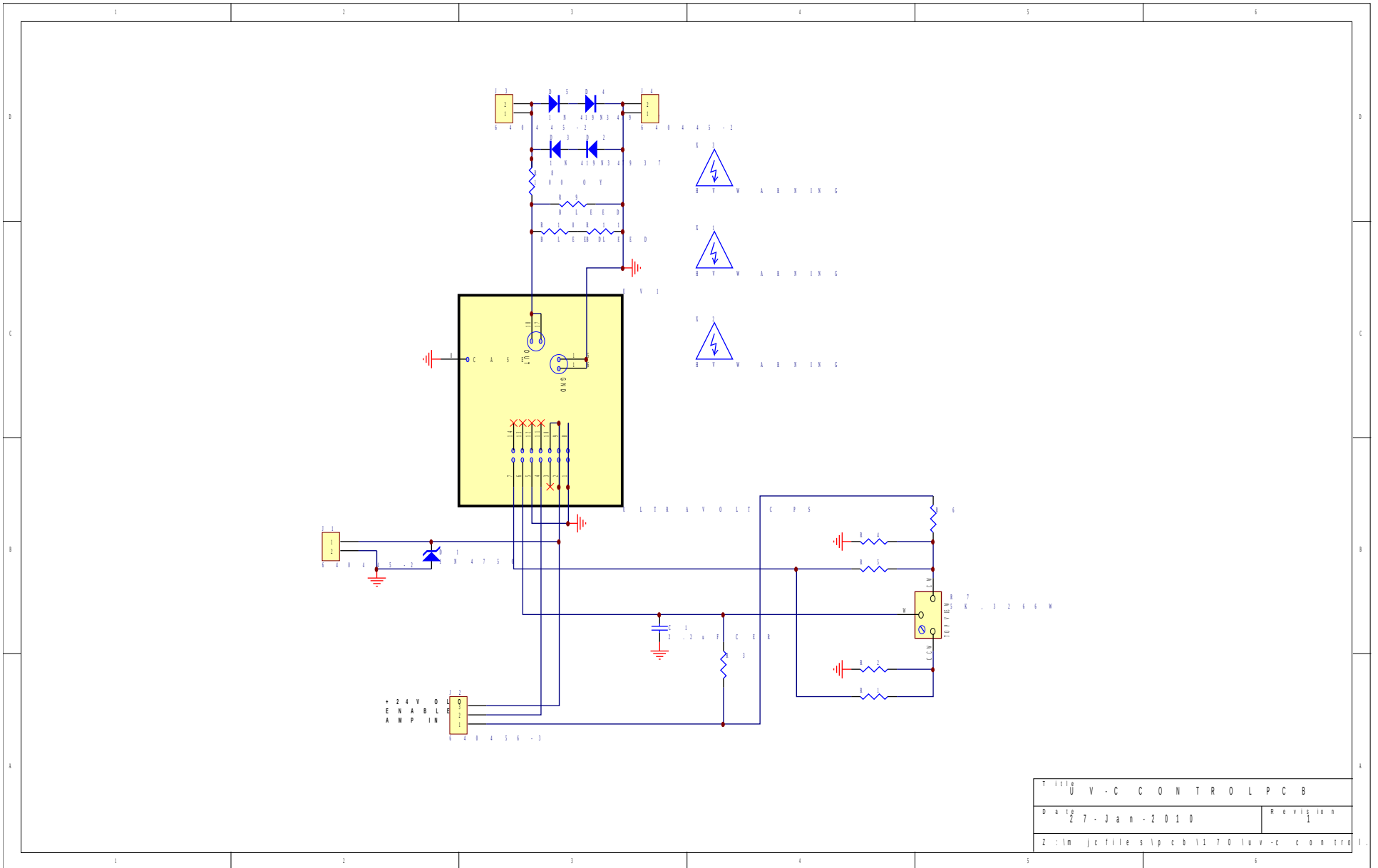

Title		U V - C C O N T R O L P C B
Date	27-Jan-2010	Revision
Z:\m\c\files\slp\cb\170\uv-c-control		1

MAIN WIRING

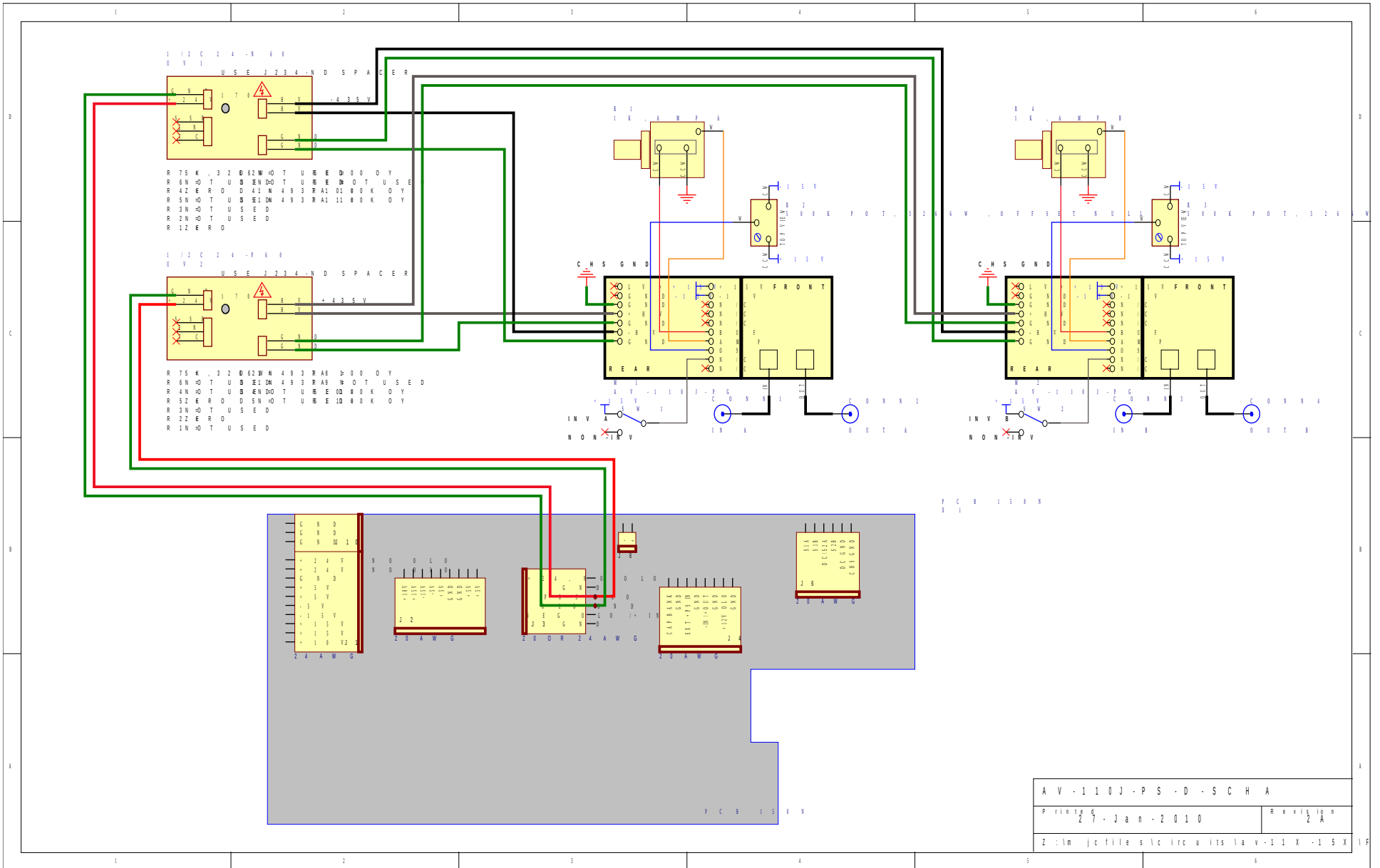

PERFORMANCE CHECK SHEET