



AVTECH ELECTROSYSTEMS LTD.

NANOSECOND WAVEFORM ELECTRONICS
SINCE 1975

P.O. BOX 265
OGDENSBURG, NY
U.S.A. 13669-0265
TEL: (315) 472-5270
FAX: (613) 226-2802

TEL: 1-800-265-6681
FAX: 1-800-561-1970

e-mail: info@avtechpulse.com
<http://www.avtechpulse.com>

P.O. BOX 5120 STN. F
OTTAWA, ONTARIO
CANADA K2C 3H4
TEL: (613) 226-5772
FAX: (613) 226-2802

INSTRUCTIONS

MODEL AVO-5C-C PULSE GENERATOR

S.N.:

WARRANTY

Avtech Electrosystems Ltd. warrants products of its manufacture to be free from defects in material and workmanship under conditions of normal use. If, within one year after delivery to the original owner, and after prepaid return by the original owner, this Avtech product is found to be defective, Avtech shall at its option repair or replace said defective item. This warranty does not apply to units which have been disassembled, modified or subjected to conditions exceeding the applicable specifications or ratings. This warranty is the extent of the obligation assumed by Avtech with respect to this product and no other warranty or guarantee is either expressed or implied.

TECHNICAL SUPPORT

Phone: 613-226-5772 or 1-800-265-6681

Fax: 613-226-2802 or 1-800-561-1970

E-mail: info@avtechpulse.com

World Wide Web: <http://www.avtechpulse.com>

TABLE OF CONTENTS

WARRANTY.....	2
TABLE OF CONTENTS	3
FIG. 1: PULSE GENERATOR TEST ARRANGEMENT	4
GENERAL OPERATING INSTRUCTIONS	5
FIG. 2: FRONT PANEL CONTROLS	8
FRONT PANEL CONTROLS	9
FIG. 3: BACK PANEL CONTROLS	11
BACK PANEL CONTROLS	12
FIG. 4: SYSTEM BLOCK DIAGRAM.....	13
SYSTEM DESCRIPTION AND REPAIR PROCEDURE.....	14
FIG. 5: AVO-5C-C SL8T HEAT SINKING	15
PERFORMANCE CHECK SHEET	16

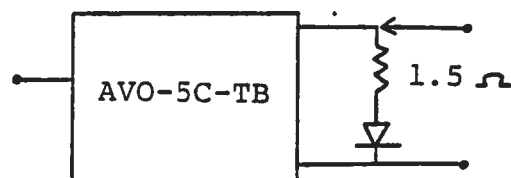
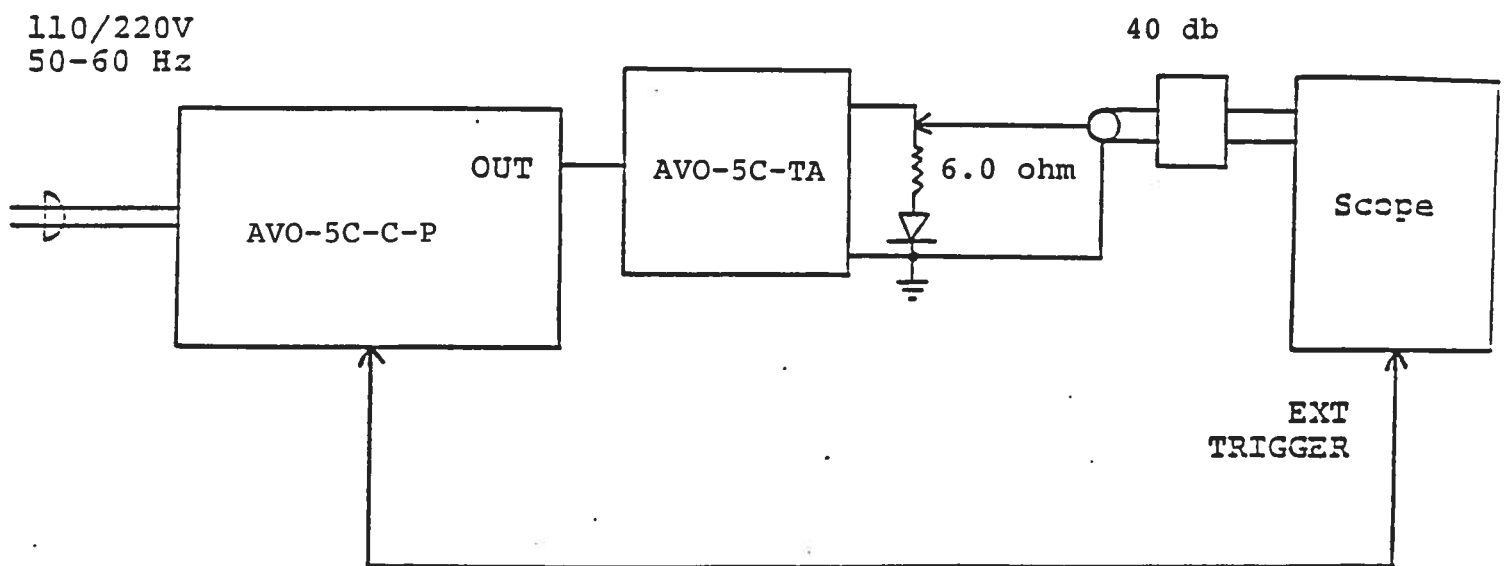
FIG. 1: PULSE GENERATOR TEST ARRANGEMENT

Note: Reverse the diode load
for AVO-5C-C-N units.

GENERAL OPERATING INSTRUCTIONS

- 1) The equipment should be connected in the general fashion shown above. Since the AVO unit provides an output pulse rise time as low as 5 ns a fast oscilloscope (at least 50 MHz and preferably 200 MHz) should be used to display the waveform. If a sampling scope is used, a 40 dB (or greater) attenuator should be used to insure a peak input to the scope of less than 0.5 Volts.
- 2) The TRIG output channel provides a +0.5 Volt 100 ns pulse.
- 3) To obtain a stable output display the PRF controls on the front panel should be set mid-range. The front panel TRIG toggle switch should be in the INT position. The front panel DELAY control and the scope triggering controls are then adjusted to obtain a stable output. The scope may then be used to set the desired PRF by rotating the PRF controls. The main output is delayed with respect to the TRIG output by about 0 to 200 ns depending on the DELAY control setting.
- 4) The AVO-5C-TA transformer module transforms the 50 Volt output of the AVO-5C mainframe to 25 Volts to 6.0 Ohm to provide a peak diode as high as 4 Amperes. The AVO-5C-TB module transforms the 50 Volt output to 12 Volts to 1.5 Ohms. The AVO-5C-T module connects to the mainframe via two parallel 50 Ohm miniature coaxial cables approx. 2 feet in length. The output terminals of the transformer module consists of a short length of microstrip transmission line protruding from the module chassis. The OUT terminal is the center conductor which is bounded on both sides by the ground plane (see below):

The diode load and series resistor (6 Ohm or 1.5 Ohm 1/2 W carbon composition resistor) should be connected between the OUT and GND terminals using very short leads (≤ 0.2 cm). The voltage across the resistor-diode load may be monitored by connecting a length of 80 mil semi-rigid 50 Ohm cable as shown below:

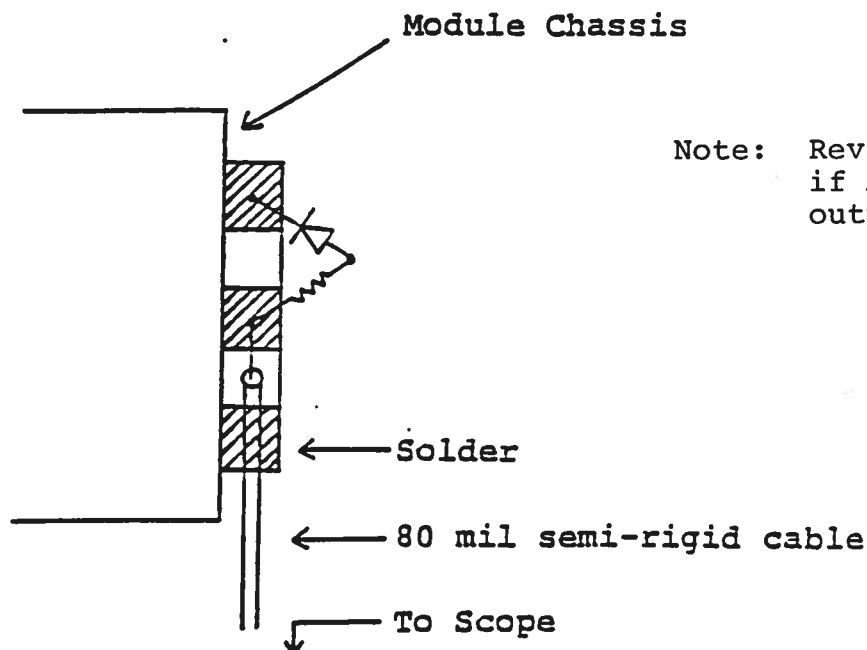

Take care to insure that during soldering the OUT conductor is not shorted to the chassis. Also, use minimal heat when soldering.

- 5) AVO-5C-C units with a serial number higher than 5600 are protected by an automatic overload protective circuit which controls the front panel overload light. If the unit is overloaded (by operating at an exceedingly high duty cycle or by operating into a short circuit), the protective circuit will turn the output of the instrument OFF and turn the indicator light ON. The light will stay ON (i.e. output OFF) for about 5 seconds after which the instrument will attempt to turn ON (i.e. light OFF) for about 1 second. If the overload condition persists, the instrument will turn OFF again (i.e. light ON) for another 5 seconds. If the overload condition has been removed, the instrument will turn on and resume normal operation. Overload conditions may be removed by:
- 1) Reducing PRF (i.e. switch to a lower range)
 - 2) Reducing pulse width (i.e. switch to a lower range)
 - 3) Removing output load short circuit (if any)

- 6) **CAUTION:** The maximum output duty cycle should not exceed 10%. For example, at 5 MHz the output pulse width should not exceed 20 ns. If severely overloaded the rear panel 1.0 Amp slow blow fuse may fail or the output switching elements (SL8T) may fail. The SL8T elements may be changed following the instructions in the Repair Section.
- 7) The output polarity is controlled by the rear panel polarity switch.
- 8) To voltage control the output pulse width, set the rear panel switch in the EXT position and apply 0 to +10V to connector A ($R_{IN} \geq 10K$). (EW option).
- 9) To voltage control the output amplitude, set the rear panel switch in the EXT position and apply 0 to +10V to connector B ($R_{IN} \geq 10K$). (EA option).
- 10) -GT Option. Triggering of the unit (in both the INT or EXT mode) is inhibited when a TTL high is applied to the rear panel GT BNC connector.
- 11) The unit can be converted from 110 to 220V 50-60 Hz operation by adjusting the voltage selector card in the rear panel fused voltage selector-cable connector assembly.
- 12) DC offset (option). The desired DC offset voltage (0 to ± 6 Volts) is applied to the OS terminals on the AVO-T module. This voltage appears directly at the AVO-T output terminals and so the current is determined by the series resistance (diode plus fixed resistance) and this current must not exceed 200 mA.
- 13) For additional assistance:

Tel: (613) 226-5772
Fax: (613) 226-2802

FIG. 2: FRONT PANEL CONTROLS

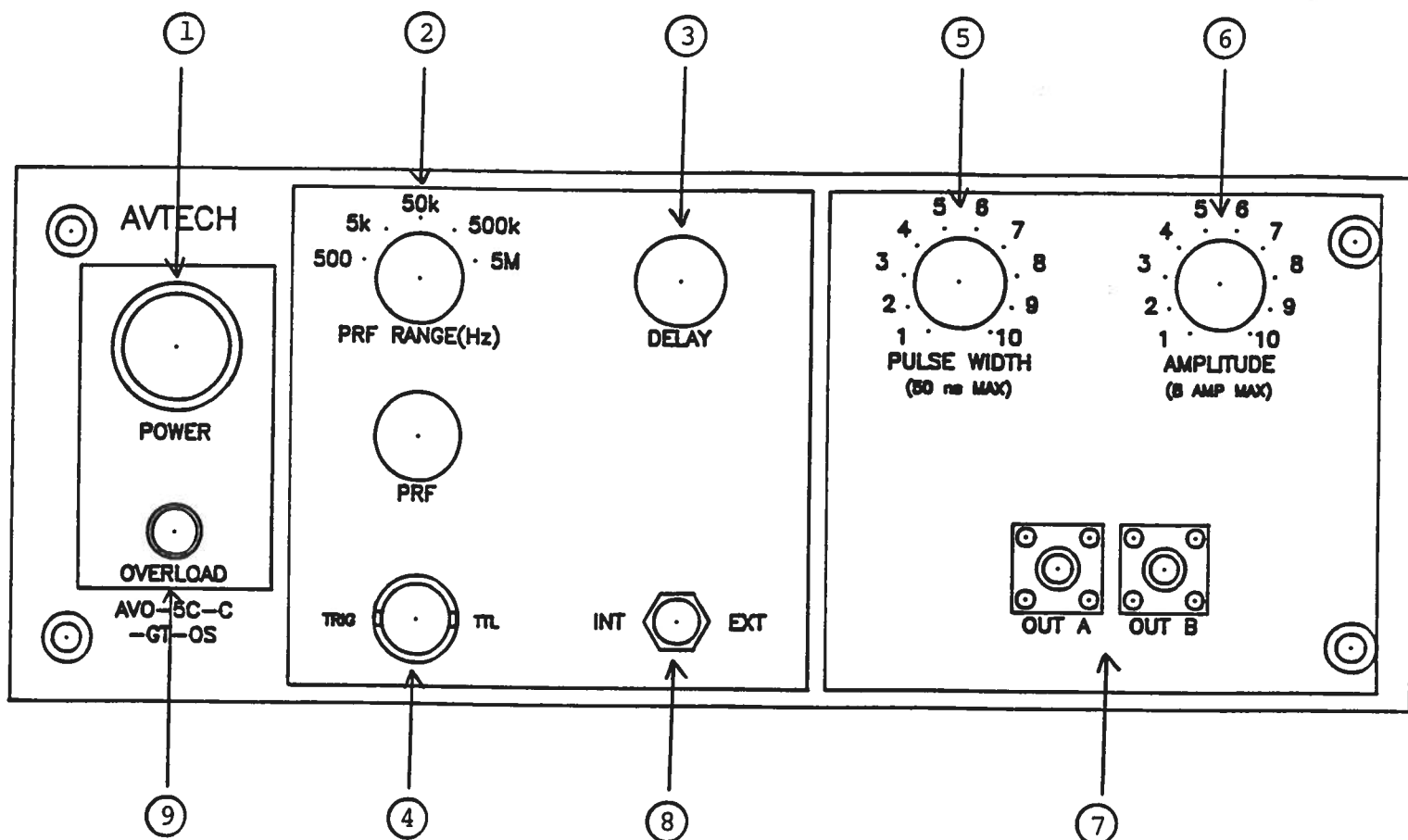

FRONT PANEL CONTROLS

- (1) ON-OFF Switch. Applies basic prime power to all stages.
- (2) PRF Control. Varies PRF from about 50 Hz to 5 MHz. The operating PRF should be set using a scope.

	PRF MIN	PRF MAX
RANGE 1	50 Hz	500 Hz
RANGE 2	500 Hz	5 kHz
RANGE 3	5 kHz	50 kHz
RANGE 4	50 kHz	500 kHz
RANGE 5	500 kHz	5.0 MHz

- (3) DELAY Control. Controls the relative delay between the reference output pulse provided at the TRIG output (4) and the main output (7). This delay is variable over the range of about 0 to 200 ns.
- (4) TRIG Output. This output precedes the main output (7) and is used to trigger the sampling scope time base. The output is a +0.5 Volt 100 ns (approx) pulse capable of driving a fifty Ohm load. The external trigger signal is applied at this input when the EXT-INT toggle switch is in the EXT position. The output pulse at (7) appears about 30 ns after the application of the TRIG pulse.
- (5) PW Control. A one turn control which varies the output pulse width from 5 to 50 ns. Note that the output duty cycle should not exceed 10%.
- (6) AMP Control. The output pulse amplitude is controlled by means of the one turn potentiometer (AMP).
- (7) OUT Connectors. Two SMA connectors for two miniature coaxial cables connected to the AVO-5C-T module.
- (8) EXT-INT Control. With this toggle switch in the INT position, the PRF of the AVO unit is controlled via an internal clock which in turn is controlled by the PRF controls. With the toggle switch in the EXT position, the AVO unit requires a 20 ns (or wider) TTL level pulse applied at the TRIG input in order to trigger the output stages.

(9) OVERLOAD INDICATOR. AVO-5C-C units with a serial number higher than 5600 are protected by an automatic overload protective circuit which controls the front panel overload light. If the unit is overloaded (by operating at an exceedingly high duty cycle or by operating into a short circuit), the protective circuit will turn the output of the instrument OFF and turn the indicator light ON. The light will stay ON (i.e. output OFF) for about 5 seconds after which the instrument will attempt to turn ON (i.e. light OFF) for about 1 second. If the overload condition persists, the instrument will turn OFF again (i.e. light ON) for another 5 seconds. If the overload condition has been removed, the instrument will turn on and resume normal operation. Overload conditions may be removed by:

- 1) Reducing PRF (i.e. switch to a lower range)
- 2) Reducing pulse width (i.e. switch to a lower range)
- 3) Removing output load short circuit (if any)

FIG. 3: BACK PANEL CONTROLS

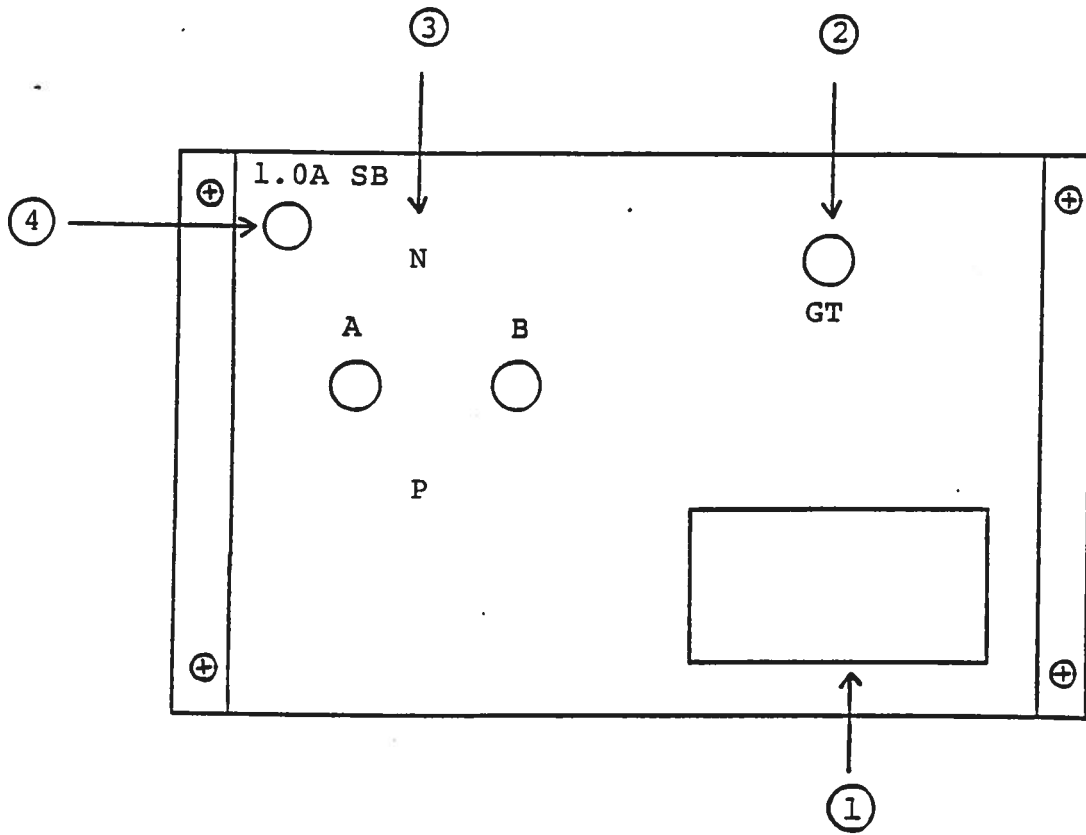

BACK PANEL CONTROLS

- (1) FUSED CONNECTOR, VOLTAGE SELECTOR. The detachable power cord is connected at this point. In addition, the removable cord is adjusted to select the desired input operating voltage. The unit also contains the main power fuse (0.5 A SB).
- (2) GT Option. Triggering of the unit (in both the internal and external modes) is inhibited when a TTL high is applied to the BNC connector.
- (3) POLARITY. The output polarity is controlled by the rear panel polarity switch.
- (4) 1.0A SB. Fuse which protects the output stage if the output duty cycle rating is exceeded.

FIG. 4: SYSTEM BLOCK DIAGRAM

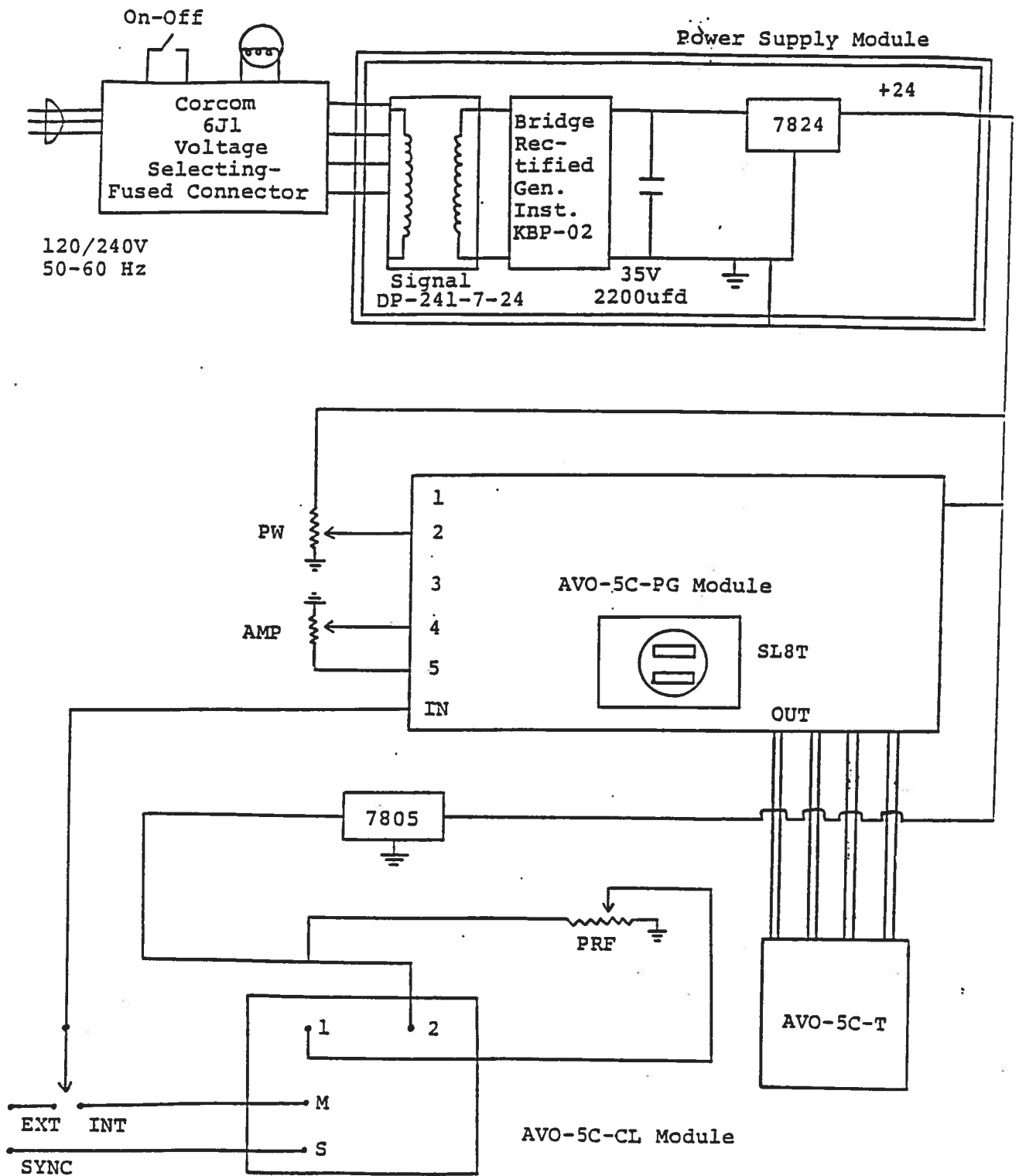

SYSTEM DESCRIPTION AND REPAIR PROCEDURE

The AVO-5C-C unit consists of the following basic modules:

- 1) AVO-5C-P-PG pulse generator module
- 2) AVO-5C clock module
- 3) +24V power supply board
- 4) AVO-5C-T output modules (A and B)

The modules are interconnected as shown in Fig. 4.

In the event of an instrument malfunction, it is most likely that the 1.0 A slow blow fuse or the main power fuse on the rear panel has blown. Replace if necessary. If the unit still does not function, it is most likely that some of the output switching elements (SL8T) may have failed due to an output short circuit condition or to a high duty cycle condition. The switching elements may be accessed by removing the cover plate on the bottom side of the instrument. The elements may be removed from their sockets by means of a needle nosed pliers after removing the four counter sunk 2-56 Phillips screws which attach the small aluminum heat sinks to the body of the instrument. The SL8T is a selected VMOS power transistor in a TO 220 package and may be checked on a curve tracer. If defective, replacement units should be ordered directly from Avtech. When replacing the SL8T switching elements, take care to insure that the short lead (of the three leads) is adjacent to the back of the chassis. (See following Fig.). The SL8T elements are electrically isolated from the small aluminum heat sinks but are bonded to the heat sinks using WAKEFIELD TYPE 155 HEAT SINK ADHESIVE.

FIG. 5: AVO-5C-C SL8T HEAT SINKING

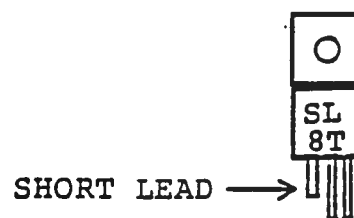
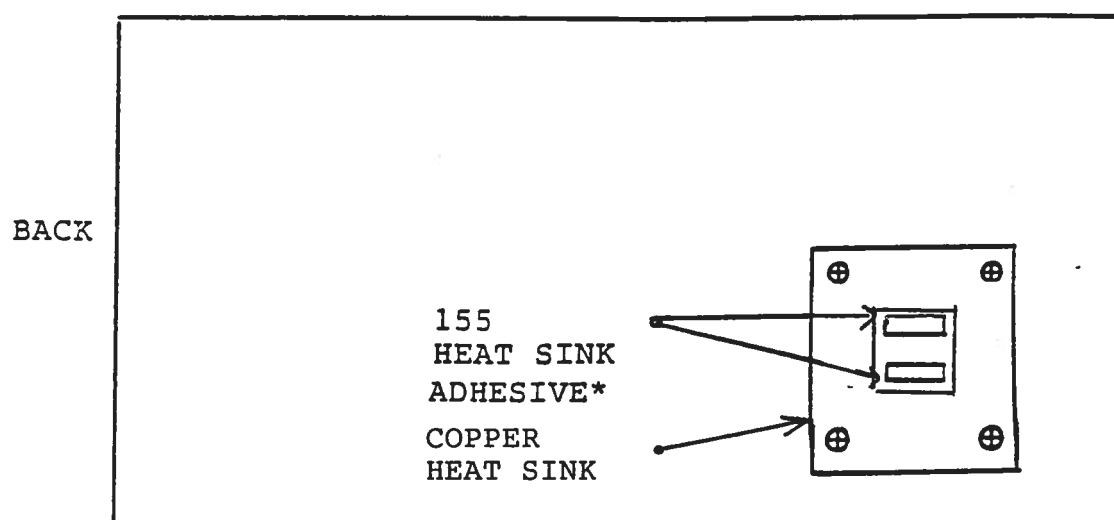

Nov 27/98

Edition G

instructword |avo-5|avo-5c-c-edg.doc