



AVTECH ELECTROSYSTEMS LTD.

NANOSECOND WAVEFORM ELECTRONICS
SINCE 1975

P.O. BOX 265
OGDENSBURG, NY
U.S.A. 13669-0265
TEL: (315) 472-5270
FAX: (613) 226-2802

TEL: 1-800-265-6681
FAX: 1-800-561-1970

e-mail: info@avtechpulse.com
<http://www.avtechpulse.com>

P.O. BOX 5120 STN. F
OTTAWA, ONTARIO
CANADA K2C 3H4
TEL: (613) 226-5772
FAX: (613) 226-2802

INSTRUCTIONS

MODEL AVN-4-C PULSE GENERATOR

S.N.:

WARRANTY

Avtech Electrosystems Ltd. warrants products of its manufacture to be free from defects in material and workmanship under conditions of normal use. If, within one year after delivery to the original owner, and after prepaid return by the original owner, this Avtech product is found to be defective, Avtech shall at its option repair or replace said defective item. This warranty does not apply to units which have been disassembled, modified or subjected to conditions exceeding the applicable specifications or ratings. This warranty is the extent of the obligation assumed by Avtech with respect to this product and no other warranty or guarantee is either expressed or implied.

TECHNICAL SUPPORT

Phone: 613-226-5772 or 1-800-265-6681

Fax: 613-226-2802 or 1-800-561-1970

E-mail: info@avtechpulse.com

World Wide Web: <http://www.avtechpulse.com>

TABLE OF CONTENTS

| | |
|---|----|
| WARRANTY | 2 |
| TABLE OF CONTENTS | 3 |
| FIG. 1: PULSE GENERATOR TEST ARRANGEMENT..... | 4 |
| GENERAL OPERATING INSTRUCTIONS | 5 |
| FIG. 2: FRONT PANEL CONTROLS | 9 |
| FRONT PANEL CONTROLS | 10 |
| FIG. 3: BACK PANEL CONTROLS..... | 12 |
| BACK PANEL CONTROLS..... | 13 |
| FIG. 4: BACK PANEL CONTROLS (UNITS WITH OT OPTION)..... | 14 |
| BACK PANEL CONTROLS (UNITS WITH OT OPTION)..... | 15 |
| TOP COVER REMOVAL | 16 |
| POWER SUPPLY AND FUSE REPLACEMENT | 17 |
| PERFORMANCE CHECK SHEET | 19 |

FIG. 1: PULSE GENERATOR TEST ARRANGEMENT

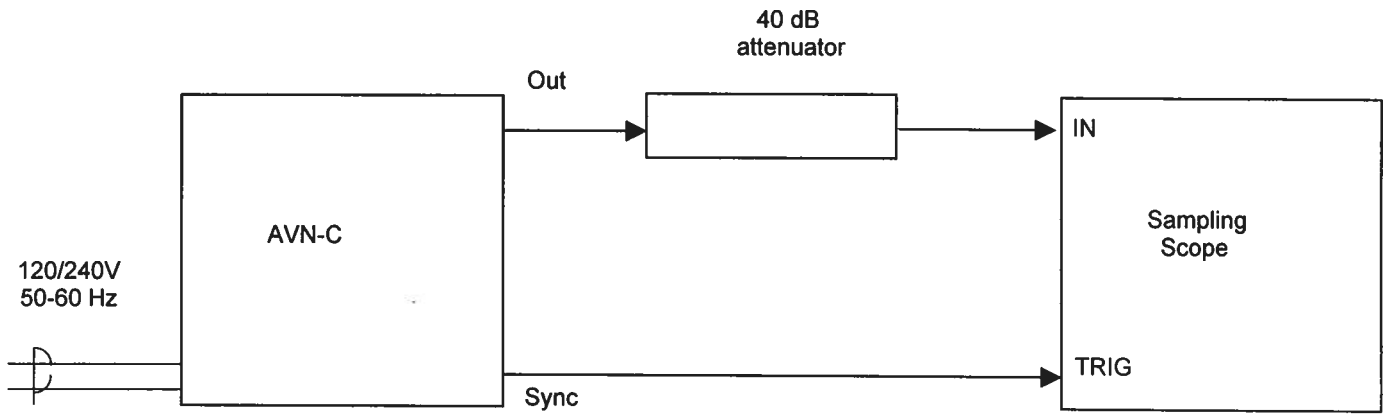

GENERAL OPERATING INSTRUCTIONS

- 1) The bandwidth capability of components and instruments used to display the pulse generator output signal (attenuators, cables, connectors, etc.) should exceed ten gigahertz.
- 2) The use of 40 dB attenuator at the sampling scope vertical input channel will insure a peak input signal to the sampling scope of less than one Volt.
- 3) To obtain a stable output display the PRF and PRF FINE controls on the front panel should be set mid-range while the PRF range switch may be in either range. The front panel TRIG toggle switch should be in the INT position. The scope triggering controls are then adjusted to obtain a stable output.
- 4) The output pulse shape is determined by the two front panel pot controls TR and TF. TR controls the leading edge of the pulse while TF controls the falling edge. Clockwise rotation of TR and TF increases the output pulse width. Initially rotate the TF pot fully clockwise and set the TR pot at mid-range. The output amplitude is controlled by the front panel AMP control and by the input signal level. Initially the AMP control should be set maximum clockwise. The CRT display will resemble the following:

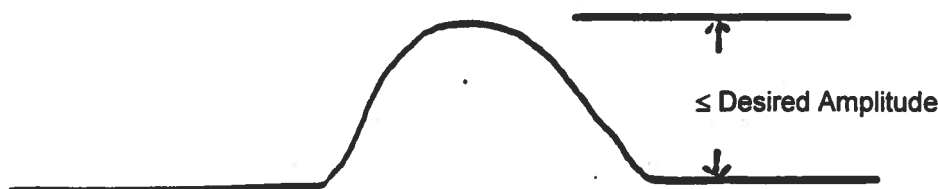

- 5) Having obtained a display of the form shown above, the desired pulse width is then obtained by adjusting the two front panel pots TR and TF. Rotate TR counterclockwise from the positive set in step 2) until a sharp 150 ps leading edge is observed. Then rotate TF counterclockwise until the desired pulse width and fall time are obtained.

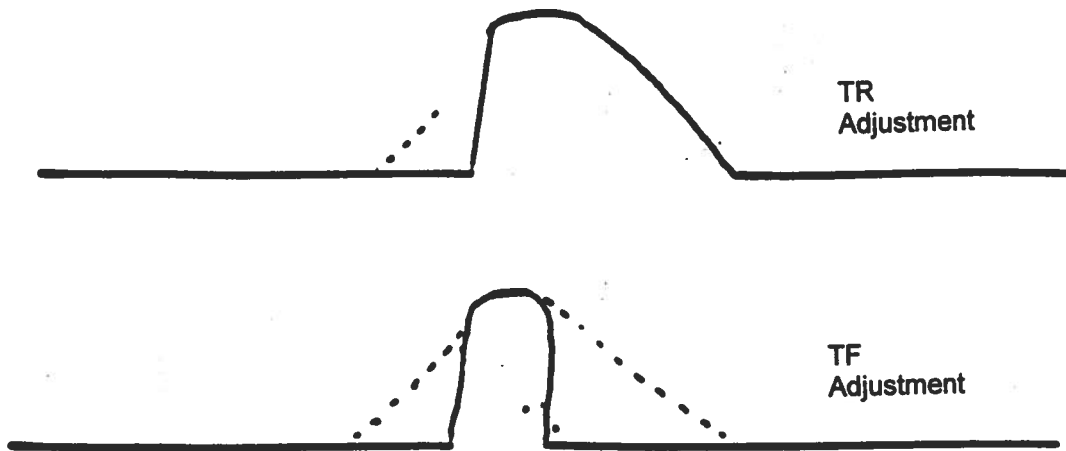

Further iterative adjustments of TR and TF will be necessary to simultaneously obtain the lowest rise time, lowest fall time, the desired pulse width, and pulse top shape, and low spurious signal level. In addition some additional adjustment of signal level may be necessary to obtain the desired amplitude. If the input frequency is then changed it will be necessary to readjust AMP, TR and TF to establish the required pulse shape. Following the above sequence it is possible to generate output pulses having amplitudes of at least 20, 15 and 5 Volts with pulse repetition frequencies in the range of 50 to 100 MHz, 150 and 250 MHz, respectively. **WARNING:** Do not operate below 50 MHz as failure may result. Also, do not exceed 20 Volts out (for frequencies of less than 100 MHz) as this too may result in failure. Failures due to operating at output signals higher than 20 Volts are not covered by the warranty.

- 6) AVN-4-C units with a serial number higher than 6600 are protected by an automatic overload protective circuit which controls the front panel overload light. If the unit is overloaded (by operating at an exceedingly high duty cycle or high output amplitude or by operating into a short circuit), the protective circuit will turn the output of the instrument OFF and turn the indicator light ON. The light will stay ON (i.e. output OFF) for about 5 seconds after which the instrument will attempt to turn ON (i.e. light OFF) for about 1 second. If the overload condition persists, the instrument will turn OFF again (i.e. light ON) for another 5 seconds. If the overload condition has been removed, the instrument will turn on and resume normal operation. Overload conditions may be removed by:
 - 1) Reducing output amplitude
 - 2) Reducing pulse width
 - 3) Removing output load short circuit (if any)
- 7) To trigger externally, set the INT-EXT switch to EXT and connect a sine wave generator to the TRIG connector. The output PRF will equal the sine wave PRF. The sine wave amplitude should be set at 0.3 VRMS.
- 8) To DC offset the output pulse connect a DC power supply set to required DC offset value to the back panel terminals marked O.S. The maximum attainable DC offset voltage is ± 50 Volts (for units without the OT or EO option only).

- 9) For units with the OT or EO options, the output DC offset is variable from +5 to -5 Volts by means of the front panel one turn OFFSET control. The offset control may be turned off by means of the rear panel ON-OFF OFFSET switch.
- 10) For units with the EO option, the output offset may be voltage controlled by setting the rear panel switch in the EXT position and applying 0 to +10 Volts between terminal A and ground ($R_{IN} \geq 10K$).
- 11) Dual Polarity Option (for units without the OT or EO options).

To invert the output of the AVN unit, connect the AVX-2-T unit to the OUT port. An inverted pulse with a rise time < 100 ps is then obtained at the OUT port of the AVX-2-T unit. To offset the inverted pulse, apply the required DC level to the DC terminal of the AVX-2-T unit.

- 12) Dual Polarity Option (for units with the OT or EO options).

To invert the output of the AVN unit, connect the AVX-2-T unit to the OUT port. An inverted pulse with a rise time < 100 ps is then obtained at the OUT port of the AVX-2-T unit. To offset the inverted pulse, connect a lead from the rear panel OS OUT banana plug to the DC terminal of the AVX-2-T unit. The DC offset at the output of the AVX-2-T unit is then controlled by the front panel OFFSET control.

- 13) The chassis is cooled by convection and a self-contained fan. The fan input is accessible on the bottom surface of the unit. The input filter should be cleaned as required. Use a low-powered vacuum cleaner and do not attempt to remove the filter. Note that the fan speed will increase as the temperature of the chassis attempts to increase.
- 14) The AVN-C unit can be converted from 120 to 240V 50-60 Hz operation by adjusting the voltage selector card in the rear panel fused voltage selector-cable connector assembly.
- 15) For additional assistance:

Tel: (613) 226-5772
Fax: (613) 226-2802
Email: info@avtechpulse.com

FIG. 2: FRONT PANEL CONTROLS

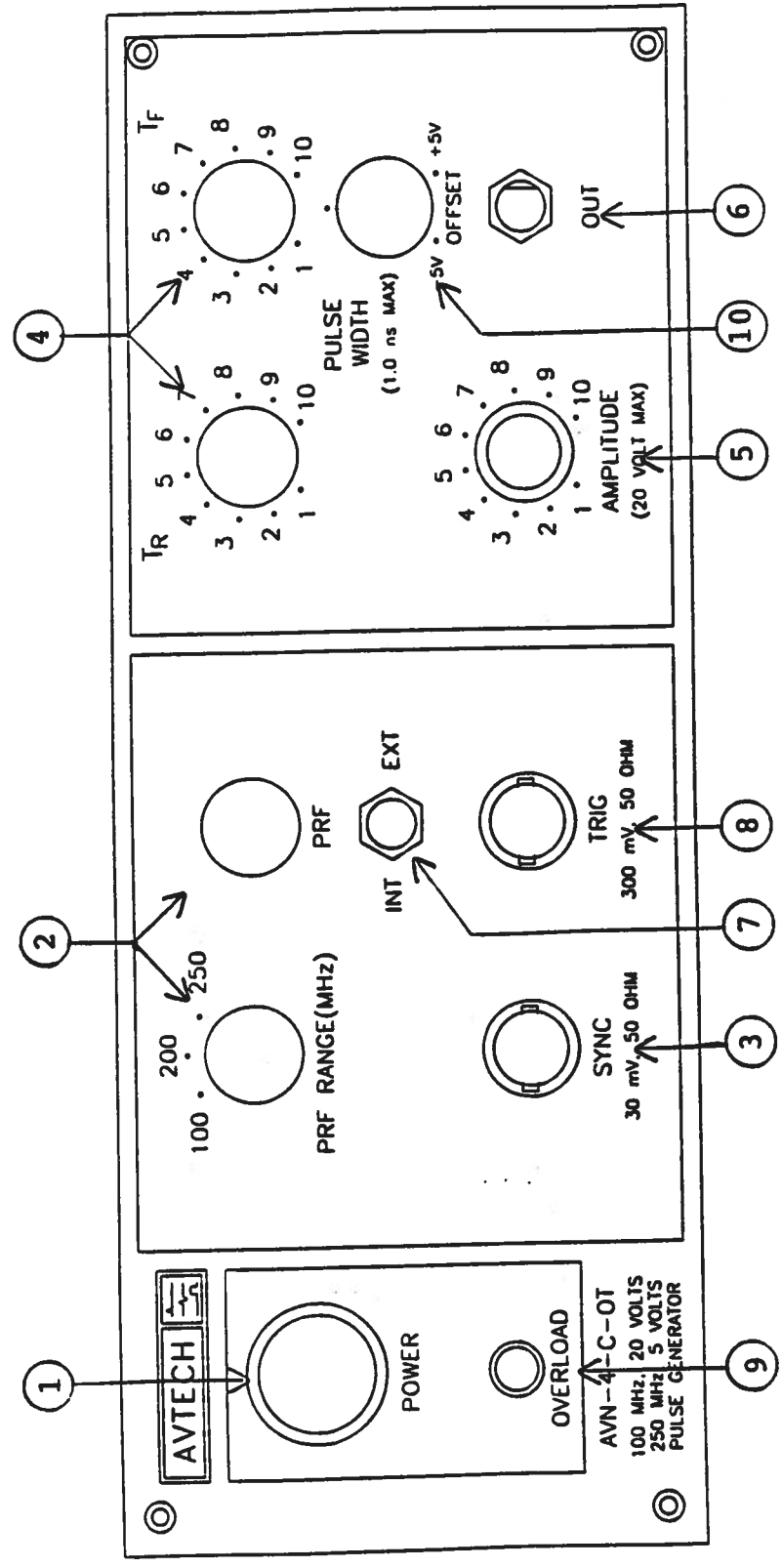

FRONT PANEL CONTROLS

- (1) ON-OFF Switch. Applies basic prime power to all stages.
- (2) PRF Control. PRF RANGE and PRF controls determine output PRF as follows:

| | PRF MIN | PRF MAX |
|---------|---------|---------|
| Range 1 | 50 MHz | 125 |
| Range 2 | 100 | 200 |
| Range 3 | 100 | 250 |

- (3) SYNC Output. This output is approximately coincident with the main output (6) and is used to trigger the sampling scope time base. The output is a 30 mV sine wave capable of driving a fifty-Ohm load.
- (4) PW Control. One-turn controls which vary the output pulse width. The output pulse shape is determined by the two front panel pot controls TR and TF. TR controls the leading edge of the pulse while TF controls the falling edge. Clockwise rotation of TR and TF increases the output pulse width.
- (5) AMP Control. A one-turn control, which varies the output pulse amplitude from 0 to max output to a fifty Ohm load.
- (6) OUT Connector. SMA connector provides output to a fifty-Ohm load.
- (7) EXT-INT Control. With this toggle switch in the INT position, the PRF of the AVN unit is controlled via an internal clock, which in turn is controlled by the PRF controls. With the toggle switch in the EXT position, the AVN unit requires a 0.3 V RMS sine wave applied at the TRIG input in order to trigger the output stages. In addition, in this mode, the scope time base must be triggered by the external trigger source.
- (8) TRIG Input. The external trigger signal is applied at this input when the EXT-INT toggle switch is in the EXT position.

- (9) OVERLOAD. AVN-4-C units with a serial number higher than 6600 are protected by an automatic overload protective circuit, which controls the front panel overload light. If the unit is overloaded (by operating at an exceedingly high duty cycle or high output amplitude or by operating into a short circuit), the protective circuit will turn the output of the instrument OFF and turn the indicator light ON. The light will stay ON (i.e. output OFF) for about 5 seconds after which the instrument will attempt to turn ON (i.e. light OFF) for about second. If the overload condition persists, the instrument will turn OFF again (i.e. light ON) for another 5 seconds. If the overload condition has been removed, the instrument will turn on and resume normal operation. Overload conditions may be removed by:
- 1) Reducing output amplitude
 - 2) Reducing pulse width
 - 3) Removing output load short circuit (if any)
- (10) DC OFFSET. For units with the OT or EO options, the output DC offset is variable from +5 to -5 Volts by means of the front panel one-turn OFFSET control. The offset control may be turned off by means of the rear panel ON-OFF OFFSET switch.

FIG. 3: BACK PANEL CONTROLS

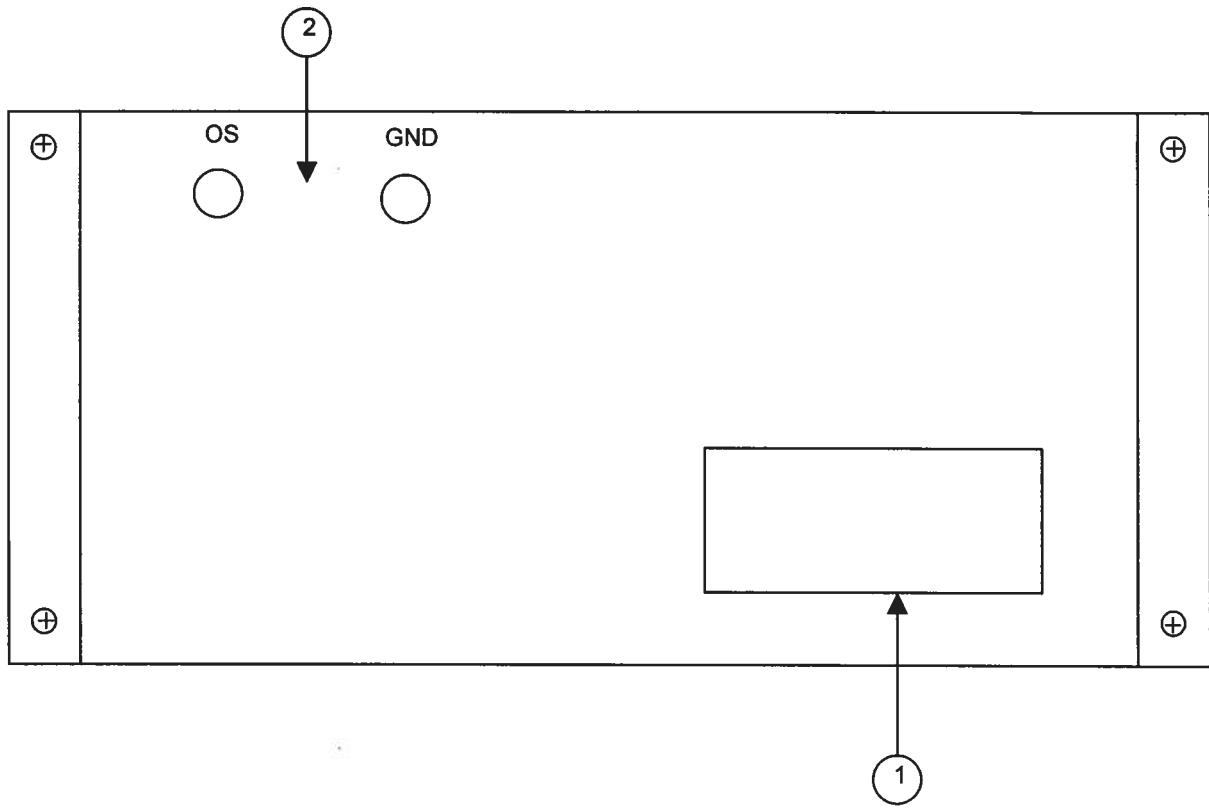

BACK PANEL CONTROLS

- (1) FUSED CONNECTOR, VOLTAGE SELECTOR. The detachable power cord is connected at this point. In addition, the removable cord is adjusted to select the desired input operating voltage. The unit also contains the main power fuse.

For AC line voltages of 110-120V, the power selector card should be installed so that the "120" marking is visible from the rear of the instrument.

For AC line voltages of 220-240V, the power selector card should be installed so that the "240" marking is visible from the rear of the instrument.

If it is not set for the proper voltage, remove the fuse and then grasp the card with a pair of pliers and remove it. Rotate horizontally through 180 degrees. Reinstall the card and the correct fuse.

In the 120V setting, a 1.0A slow blow fuse is required. In the 240V setting, a 0.5A A slow blow fuse is required.

- (2) DC OFFSET Input. To DC offset the output pulse, connect a DC power supply set to the desired offset value to these terminals. The maximum allowable DC offset voltage is +50 Volts (+250 mA).

FIG. 4: BACK PANEL CONTROLS (UNITS WITH OT OPTION)

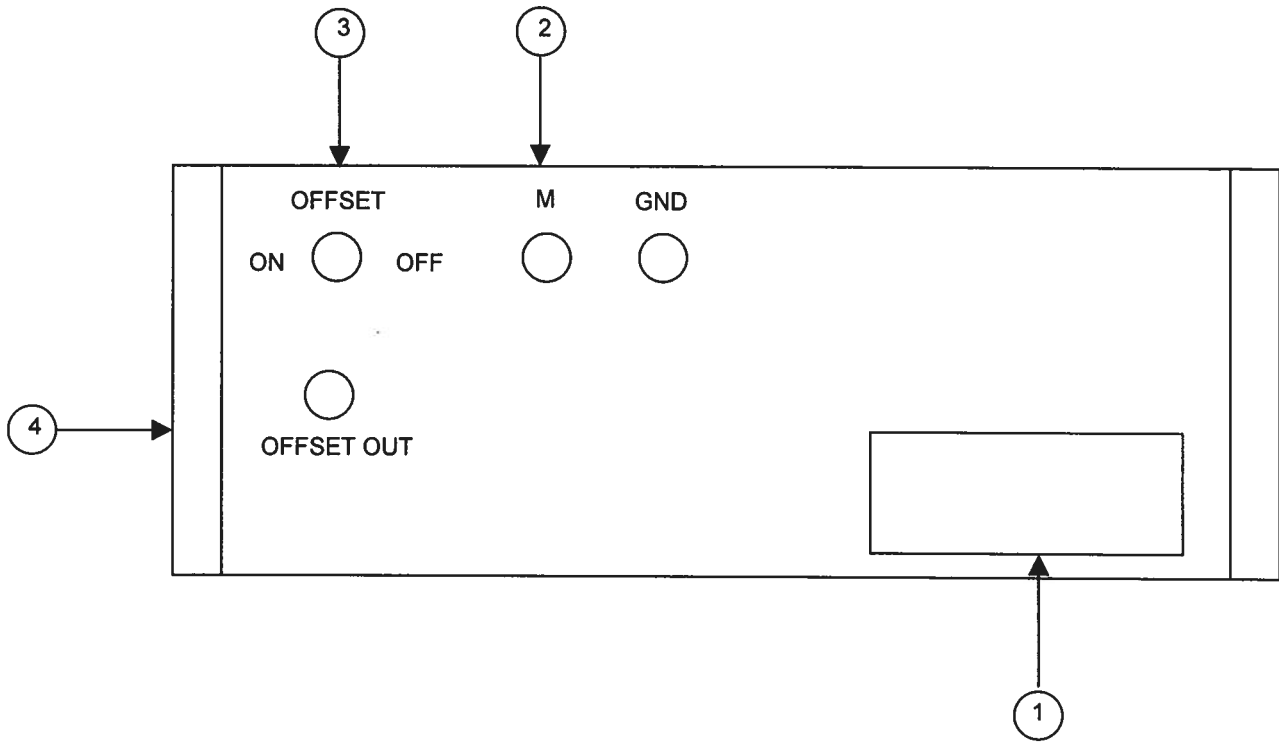

BACK PANEL CONTROLS (UNITS WITH OT OPTION)

- 1) FUSED CONNECTOR, VOLTAGE SELECTOR. The detachable power cord is connected at this point. In addition, the removable cord is adjusted to select the desired input operating voltage. The unit also contains the main power fuse.

For AC line voltages of 110-120V, the power selector card should be installed so that the "120" marking is visible from the rear of the instrument.

For AC line voltages of 220-240V, the power selector card should be installed so that the "240" marking is visible from the rear of the instrument.

If it is not set for the proper voltage, remove the fuse and then grasp the card with a pair of pliers and remove it. Rotate horizontally through 180 degrees. Reinstall the card and the correct fuse.

In the 120V setting, a 1.0A slow blow fuse is required. In the 240V setting, a 0.5A slow blow fuse is required.

- 2) MONITOR OUT M. Provides an attenuated (x10) coincident replica of the main positive output pulse to fifty Ohms (option).
- 3) DC OFFSET. To turn DC output offset OFF put toggle switch in the OFF position.
- 4) OFFSET OUT. To offset an inverted output pulse, connect a lead from the OFFSET OUT terminal to the DC terminal of the AVX-2-T unit. The DC offset at the output of the AVX-2-T unit is then controlled by the front panel OFFSET control.

TOP COVER REMOVAL

The interior of the instrument may be accessed by removing the four Phillips screws on the top panel. With the four screws removed, the top cover may be slid back (and off).

POWER SUPPLY AND FUSE REPLACEMENT

This instrument has three fuses (plus one spare). One, which protects the AC input, is located in the rear-panel power entry module, as described in the “Rear Panel Controls” section of this manual. If the power appears to have failed, check the AC fuse first.

The other two fuses (plus one spare) are located on the internal DC power supply, as shown below:

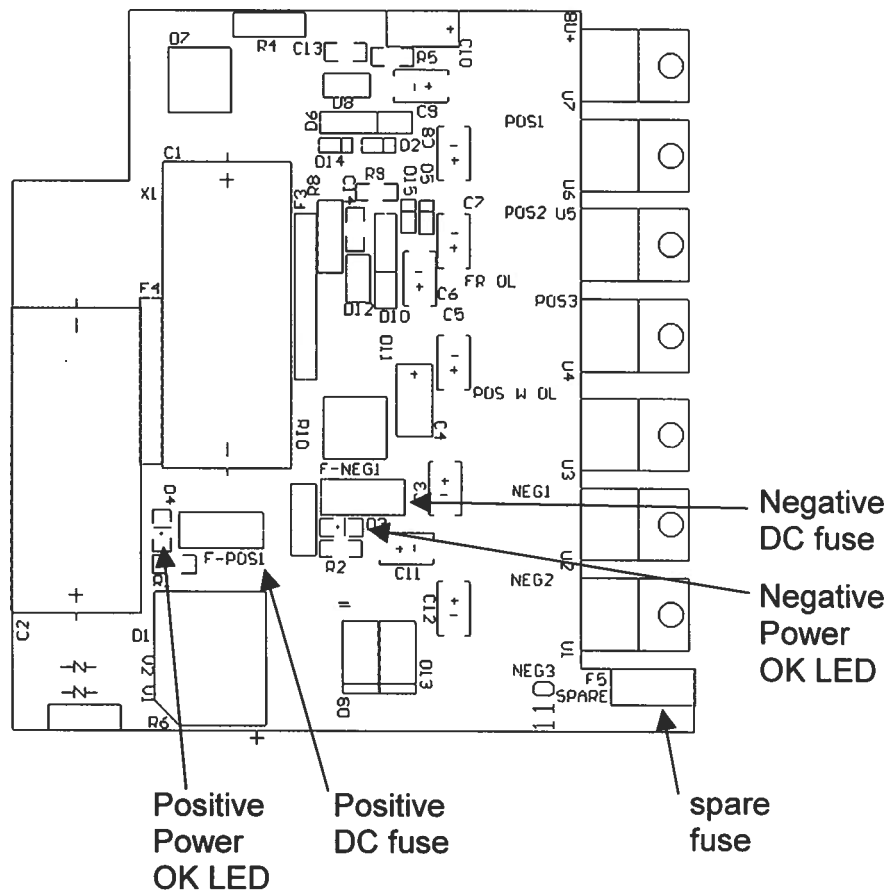

The positive fuse and the spare fuse on this circuit board are 1A slow-blow fuses, Littlefuse part number R452001. (This fuse can be ordered from Digikey, www.digikey.com. The Digikey part number is F1343CT-ND). The negative fuse is a 0.5A slow-blow fuse (Littlefuse R452.500, Digikey part number F1341CT-ND).

If you suspect that the DC fuses are blown, follow this procedure:

1. Remove the top cover, by removing the four Phillips screws on the top cover and then sliding the cover back and off.

2. Locate the two "Power OK" LEDs on the power supply circuit board, as illustrated above.
3. Turn on the instrument.
4. Observe the "Power OK" LEDs. If the fuses are not blown, the two LEDs will be lit (bright red). If one of the LEDs is not lit, the fuse next to it has blown.
5. Turn off the instrument.
6. If a fuse is blown, use needle-nose pliers to remove the blown fuse from its surface-mount holder.
7. Replace the fuse.