



AVTECH ELECTROSYSTEMS LTD.

NANOSECOND WAVEFORM ELECTRONICS
SINCE 1975

P.O. BOX 265
OGDENSBURG, NY
U.S.A. 13669-0265
TEL: (315) 472-5270
FAX: (613) 226-2802

TEL: 1-800-265-6681
FAX: 1-800-561-1970

e-mail: info@avtechpulse.com
<http://www.avtechpulse.com/>

BOX 5120, LCD MERIVALE
OTTAWA, ONTARIO
CANADA K2C 3H4
TEL: (613) 226-5772
FAX: (613) 226-2802

INSTRUCTIONS

MODEL AVO-9A-C-AK1-P-P2-VICB-CSA

0 TO 200 mA, 200 ps RISE TIME

HIGH PERFORMANCE LASER DIODE DRIVER

WITH PLUG-IN SOCKET OUTPUT MODULE

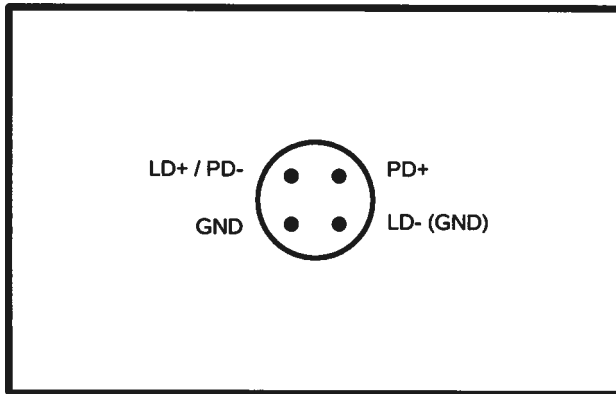

AVX-S1 OUTPUT MODULE, SOCKET VIEW

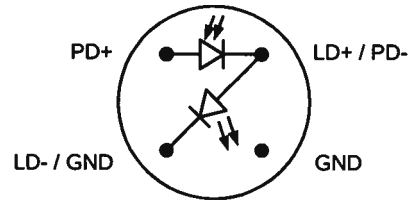

**MATCHING USER-SUPPLIED
DIODE PACKAGE
(BOTTOM VIEW).
5.6 mm PACKAGE.**

SERIAL NUMBER: _____

WARRANTY

Avtech Electrosystems Ltd. warrants products of its manufacture to be free from defects in material and workmanship under conditions of normal use. If, within one year after delivery to the original owner, and after prepaid return by the original owner, this Avtech product is found to be defective, Avtech shall at its option repair or replace said defective item. This warranty does not apply to units which have been disassembled, modified or subjected to conditions exceeding the applicable specifications or ratings. This warranty is the extent of the obligation assumed by Avtech with respect to this product and no other warranty or guarantee is either expressed or implied.

TECHNICAL SUPPORT

Phone: 613-226-5772 or 1-800-265-6681

Fax: 613-226-2802 or 1-800-561-1970

E-mail: info@avtechpulse.com

World Wide Web: <http://www.avtechpulse.com>

TABLE OF CONTENTS

| | |
|--|-----------|
| WARRANTY..... | 2 |
| TECHNICAL SUPPORT..... | 2 |
| TABLE OF CONTENTS..... | 3 |
| INTRODUCTION..... | 5 |
| SPECIFICATIONS..... | 6 |
| ORIGINAL QUOTATION..... | 7 |
| EUROPEAN REGULATORY NOTES..... | 8 |
| EC DECLARATION OF CONFORMITY..... | 8 |
| DIRECTIVE 2002/95/EC (RoHS)..... | 8 |
| CSA EVALUATION..... | 9 |
| INSTALLATION..... | 10 |
| VISUAL CHECK..... | 10 |
| POWER RATINGS..... | 10 |
| CONNECTION TO THE POWER SUPPLY..... | 10 |
| PROTECTION FROM ELECTRIC SHOCK..... | 11 |
| ENVIRONMENTAL CONDITIONS..... | 11 |
| FUSES..... | 13 |
| AC FUSE REPLACEMENT..... | 13 |
| DC FUSE REPLACEMENT..... | 14 |
| FUSE RATINGS..... | 14 |
| FRONT PANEL CONTROLS..... | 15 |
| REAR PANEL CONTROLS..... | 17 |
| GENERAL INFORMATION..... | 18 |
| MINIMAL TEST ARRANGEMENT - WITHOUT OUTPUT MODULE..... | 18 |
| NORMAL TEST ARRANGEMENT..... | 19 |
| AMPLITUDE CONTROL..... | 21 |
| BASIC PULSE CONTROL..... | 21 |
| PULSE WIDTH / AMPLITUDE INTERACTION..... | 22 |
| PROTECTING YOUR INSTRUMENT..... | 23 |
| DO NOT EXCEED 1 MHz..... | 23 |
| USE A 50Ω LOAD..... | 23 |
| INSTALL THE DIODE CORRECTLY..... | 23 |

| | |
|---|-----------|
| MECHANICAL INFORMATION..... | 24 |
| TOP COVER REMOVAL..... | 24 |
| RACK MOUNTING..... | 24 |
| ELECTROMAGNETIC INTERFERENCE..... | 24 |
| MAINTENANCE..... | 25 |
| REGULAR MAINTENANCE..... | 25 |
| CLEANING..... | 25 |
| WIRING DIAGRAMS..... | 26 |
| WIRING OF AC POWER..... | 26 |
| PCB 158K - LOW VOLTAGE POWER SUPPLY, 1/3..... | 27 |
| PCB 158K - LOW VOLTAGE POWER SUPPLY, 2/3..... | 28 |
| PCB 158K - LOW VOLTAGE POWER SUPPLY, 3/3..... | 29 |
| PCB 168B - HIGH VOLTAGE DC POWER SUPPLY..... | 30 |
| PCB 126B - OSCILLATOR AND TRIGGER CIRCUIT..... | 31 |
| MAIN WIRING - POSITIVE UNITS..... | 32 |
| PERFORMANCE CHECKSHEET..... | 33 |

Manual Reference: T:\instructword\avo-9\AVO-9A-C-AK1-P-P2-VICB-CSA,ed1.odt.
Last modified December 7, 2005.
Copyright © 2005 Avtech Electrosystems Ltd, All Rights Reserved.

INTRODUCTION

The AVO-9A-C-AK1-P-P2-VICB-CSA is a high performance instrument capable of generating up to 200 mA of current into a laser diode load, at repetition rates up to 1 MHz.

The AVO-9A-C-AK1-P-P2-VICB-CSA consists of a mainframe unit and an AVX-S1 series output module, which provides a socket into which the user's laser diode may be inserted. The mainframe generates voltage pulses of between 0 and +13V. The output module connects to the instrument mainframe via a detachable 2 foot long coaxial cable. The output module contains the necessary elements to match the laser diode to the pulse generator mainframe. A DC bias current of 0 to +100 mA may be applied to the laser diode by applying the desired DC current to a solder terminal on the output module. The output modules include an SMA output connector that provides an attenuated coincident replica of the diode current.

The AVX-S1 output module supplied with the AVO-9A-C-AK1-P-P2-VICB-CSA is specifically designed to accommodate 4-pin 5.6mm diodes with the pinout illustrated below (for example, the ULM Photonics ULM850-02-TT-HSMAPP, ULM850-02-TT-HSMAOP, ULM850-02-TT-H56BPP, ULM850-02-TT-H56BOP, and ULM850-02-TT-H56FOP diodes):

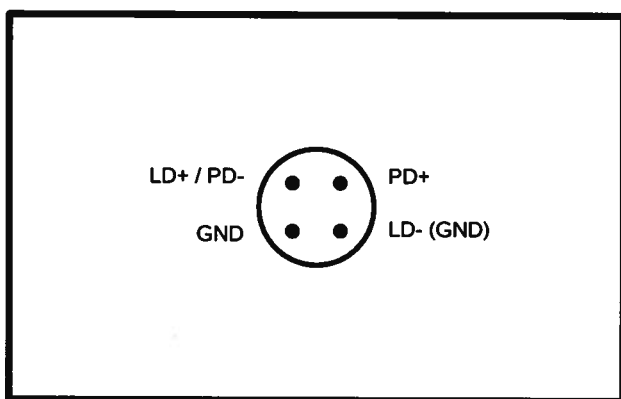

AVX-S1 OUTPUT MODULE, SOCKET VIEW

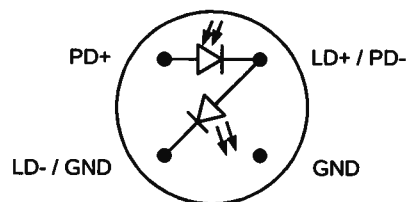

**MATCHING USER-SUPPLIED
DIODE PACKAGE
(BOTTOM VIEW).
5.6 mm PACKAGE.**

SPECIFICATIONS

| | | |
|---|---|--|
| Model: | AVO-9A-C-AK1-P-P2-VICB-CSA | |
| Amplitude ¹ : | 0 to 200 mA | |
| Maximum voltage output of mainframe ($V_{\text{MAINFRAME}}$): | 13V | |
| Allowed load voltage range: | 0 to 3V | |
| Pulse width (FWHM): | 0.4 to 4 ns | |
| Minimum pulse repetition frequency (PRF): | 100 Hz | |
| Maximum PRF: | 1 MHz | |
| Rise and fall times (20%-80%): | ≤ 200 ps | |
| Related 50 Ω series: | AVP-AV-1 | |
| Polarity: | Positive | |
| Propagation delay: (Ext trig in to pulse out) | ≤ 50 ns | |
| Jitter: (Ext trig in to pulse out) | ± 15 ps | |
| DC offset or bias insertion: | Apply required DC bias current in the range of ± 100 mA to solder terminal on output module. | |
| Sync delay: (sync out to pulse out) | Variable 0 to 200 ns | |
| Sync output (to 50 Ω): | + 3 Volts, 200 ns | |
| Trigger required (ext trig mode): | + 5 V (TTL), ≥ 50 ns | |
| Connectors: | Out: | User-specified socket. |
| | Other: | Trig: BNC, Monitor: SMA |
| Recommended accessory kit: | Add the suffix "-AK1" to the model number to include the recommended accessory kit. Consists of three SMA, 18 GHz, 2 Watt attenuators (10, 20 & 30 dB) for use on the output, and two 50 Ohm, 1 GHz, 1 Watt feed-through terminators (one SMA, one BNC) for use on external trigger inputs. | |
| Power requirements: | 100 - 240 Volts, 50 - 60 Hz | |
| Dimensions: | Mainframe: | 100 x 430 x 375 mm (3.9" x 17" x 14.8"), anodized aluminum, with blue plastic trim |
| (H x W x D) | Output module: | 41 x 66 x 76 mm (1.6" x 2.6" x 3.0"), cast aluminum, blue enamel |
| Temperature range: | +5°C to +40°C | |

1) For operation at amplitudes of less than 20% of full-scale, best results will be obtained by setting the amplitude near full-scale and using external attenuators on the output, between the mainframe and the output module. Attenuators are available in the -AK1 accessory kit option.

ORIGINAL QUOTATION

XXXXX,

XXXXX has requested that we modify our specifications slightly, and re-quote to you as follows:

Quote number: 12757

Model number: AVO-9A-C-AK1-P-P2-VICB-CSA

Description: Laser Diode Driver (Pulsed Voltage)

-P-P2-VICB Option: This option indicates that the output module has a socket and matching network that is mechanically compatible with the user-supplied ULM Photonics ULM850-02-TT-HSMAPP, ULM850-02-TT-HSMAOP, ULM850-02-TT-H56BPP, ULM850-02-TT-H56BOP, and ULM850-02-TT-H56FOP diodes. The pinout is arranged such that a positive pulse is applied to the VCSEL anode pin, and all other pins are grounded. (It is important that the end-user confirm that this arrangement is suitable for the intended application.)

-AK1 Option: Recommended accessory kit. Consists of three SMA, 18 GHz, 2 Watt attenuators (10, 20 & 30 dB) for use on the output, and two 50 Ohm, 1 GHz, 1 Watt feed-through terminators (one SMA, one BNC) for use on external trigger inputs. This attenuators in this kit are necessary when amplitudes less than 40 mA are desired.

-CSA Option: Provides Entela CSA certification (which affixes a blue sticker reading "Field Evaluation - Complies with CSA Model Code SPE-1000 and Canadian Electrical Code Part 1").

Pricing, manuals, datasheets: <http://www.avtechpulse.com/laser/avo-9a>

Price: \$XXXXX US Dollars each, FOB destination (includes 5% academic discount). GST: 7% extra.

Quote valid for: 60 days

Estimated delivery: 60 days after receipt of order.

Please call or email me if I can be of further assistance.

Thank you for your interest in our products!

Mary Budarick
Sales Manager

MB:mjc

EUROPEAN REGULATORY NOTES

EC DECLARATION OF CONFORMITY

We

Avtech Electrosystems Ltd.
P.O. Box 5120, LCD Merivale
Ottawa, Ontario
Canada K2C 3H4

declare that this pulse generator meets the intent of Directive 89/336/EEC for Electromagnetic Compatibility. Compliance pertains to the following specifications as listed in the official Journal of the European Communities:

EN 50081-1 Emission

EN 50082-1 Immunity

and that this pulse generator meets the intent of the Low Voltage Directive 72/23/EEC as amended by 93/68/EEC. Compliance pertains to the following specifications as listed in the official Journal of the European Communities:

EN 61010-1:2001 Safety requirements for electrical equipment for measurement, control, and laboratory use



DIRECTIVE 2002/95/EC (RoHS)

This instrument is exempt from Directive 2002/95/EC of the European Parliament and of the Council of 27 January 2003 on the Restriction of the use of certain Hazardous Substances (RoHS) in electrical and electronic equipment. Specifically, Avtech instruments are considered "Monitoring and control instruments" (Category 9) as defined in Annex 1A of Directive 2002/96/EC. The Directive 2002/95/EC only applies to Directive 2002/96/EC categories 1-7 and 10, as stated in the "Article 2 - Scope" section of Directive 2002/95/EC.

CSA EVALUATION

The AVO-9A-C-AK1-P-P2-VICB-CSA (S/N 11361) has received a field evaluation (FE-25090-5) for compliance with CSA Model Code SPE-1000 and Canadian Electrical Code Part 1. The report is attached below:



**FIELD EVALUATION REPORT
HISTORY DOCUMENT**

Date: DEC 7/05 FE - 25090-5
Report by: M.A.
Office: J.P.
Location of Inspection: CUSTOMER
Attention: WALTER CHUDOBIRIK
CUSTOMER: AVITECH
PRODUCT: PULSED GENERATOR

CAUTION NOTICES

Replace fuse with same type and rating More than one (1) power supply Other: See alterations
 Disconnect supply before servicing
Permanent Cord Connected # of Conductors 3
Manufacturer's Name: AVITECH Cat/Model No. AVO-9A-C
Electrical Rating 120 Volts AC 60 Hz 0.5 AMPS 1 ph
Dielectric Strength N/A Volts AC By Inspector On File
Flame Test O.K. N/A Max Risk Current _____ ua Risk Class _____

DECLARATION: The following technical requirements were used in the evaluation of the product covered in this report.

CSA Std C22.2 No(s): _____ Provincial Guidelines Model Code SPE 1000
UL Std(s): _____ CBC Code NBC Code

ALTERATIONS:

N/A

Note: Evaluation made under the Field Evaluation Service shall not be considered as the equivalent of Certification.

INSTALLATION

VISUAL CHECK

After unpacking the instrument mainframe and the transformer module, examine to ensure that they have not been damaged in shipment. Visually inspect all connectors, knobs, and handles. Confirm that a power cord and an instrumentation manual (this manual), are with the instrument. If the instrument has been damaged, file a claim immediately with the company that transported the instrument.

POWER RATINGS

This instrument is intended to operate from 100 - 240 V, 50 - 60 Hz.

The maximum power consumption is 57 Watts. Please see the "FUSES" section for information about the appropriate AC and DC fuses.

This instrument is an "Installation Category II" instrument, intended for operation from a normal single-phase supply.

CONNECTION TO THE POWER SUPPLY

An IEC-320 three-pronged recessed male socket is provided on the back panel for AC power connection to the instrument. One end of the detachable power cord that is supplied with the instrument plugs into this socket. The other end of the detachable power cord plugs into the local mains supply. Use only the cable supplied with the instrument. The mains supply must be earthed, and the cord used to connect the instrument to the mains supply must provide an earth connection. (The supplied cord does this.)

 **Warning:** Failure to use a grounded outlet may result in injury or death due to electric shock. This product uses a power cord with a ground connection. It must be connected to a properly grounded outlet. The instrument chassis is connected to the ground wire in the power cord.

The table below describes the power cord that is supplied with this instrument, depending on the destination region:

| Destination Region | Description | Manufacturer | Part Number |
|---------------------------------------|---|---|--------------|
| Continental Europe | European CEE 7/7 "Schuko" 230V, 50Hz | Volex (http://www.volex.com) | 17850-C3-326 |
| United Kingdom | BS 1363, 230V, 50Hz | Volex (http://www.volex.com) | 17962-C3-10 |
| Switzerland | SEV 1011, 230V, 50Hz | Volex (http://www.volex.com) | 2102H-C3-10 |
| Israel | SI 32, 220V, 50Hz | Volex (http://www.volex.com) | 2115H-C3-10 |
| North America, and all other areas | NEMA 5-15, 120V, 60 Hz | Volex (http://www.volex.com) | 17250-B1-10 |
| | | Qualtek (http://www.qualtekusa.com) | 312007-01 |

PROTECTION FROM ELECTRIC SHOCK

 Operators of this instrument must be protected from electric shock at all times. The owner must ensure that operators are prevented access and/or are insulated from every connection point. In some cases, connections must be exposed to potential human contact. Operators must be trained to protect themselves from the risk of electric shock. This instrument is intended for use by qualified personnel who recognize shock hazards and are familiar with safety precautions required to avoid possibly injury. In particular, operators should:

1. Keep exposed high-voltage wiring to an absolute minimum.
2. Wherever possible, use shielded connectors and cabling.
3. Connect and disconnect loads and cables only when the instrument is turned off.
4. Keep in mind that all cables, connectors, oscilloscope probes, and loads must have an appropriate voltage rating.
5. Do not attempt any repairs on the instrument, beyond the fuse replacement procedures described in this manual. Contact Avtech technical support (see page 2 for contact information) if the instrument requires servicing. Service is to be performed solely by qualified service personnel.

ENVIRONMENTAL CONDITIONS

This instrument is intended for use under the following conditions:

1. indoor use;
2. altitude up to 2 000 m;
3. temperature 5 °C to 40 °C;
4. maximum relative humidity 80 % for temperatures up to 31 °C decreasing linearly to 50 % relative humidity at 40 °C;

- 
5. Mains supply voltage fluctuations up to $\pm 10\%$ of the nominal voltage;
 6. no pollution or only dry, non-conductive pollution.



FUSES

This instrument contains four fuses. All are accessible from the rear-panel. Two protect the AC prime power input, and two protect the internal DC power supplies. The locations of the fuses on the rear panel are shown in the figure below:

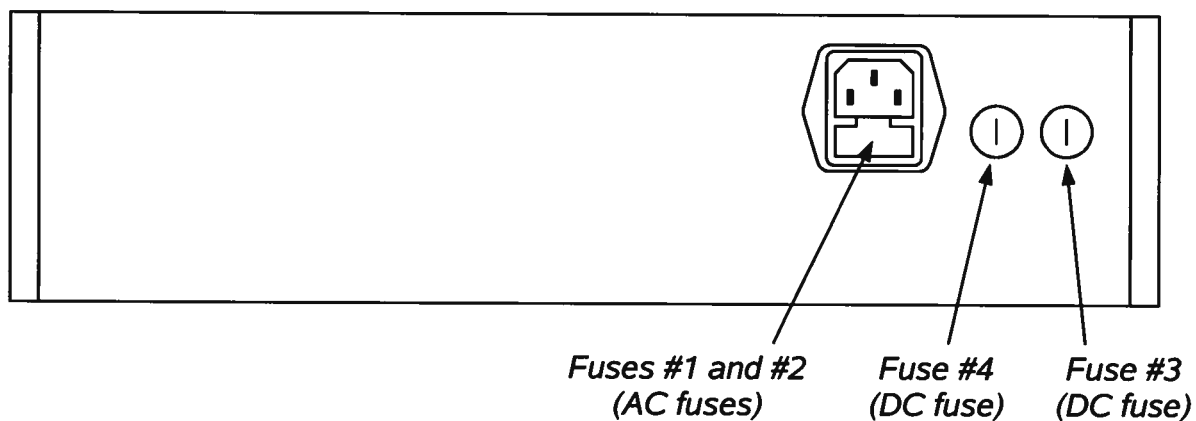

AC FUSE REPLACEMENT

To physically access the AC fuses, the power cord must be detached from the rear panel of the instrument. The fuse drawer may then be extracted using a small flat-head screwdriver, as shown below:

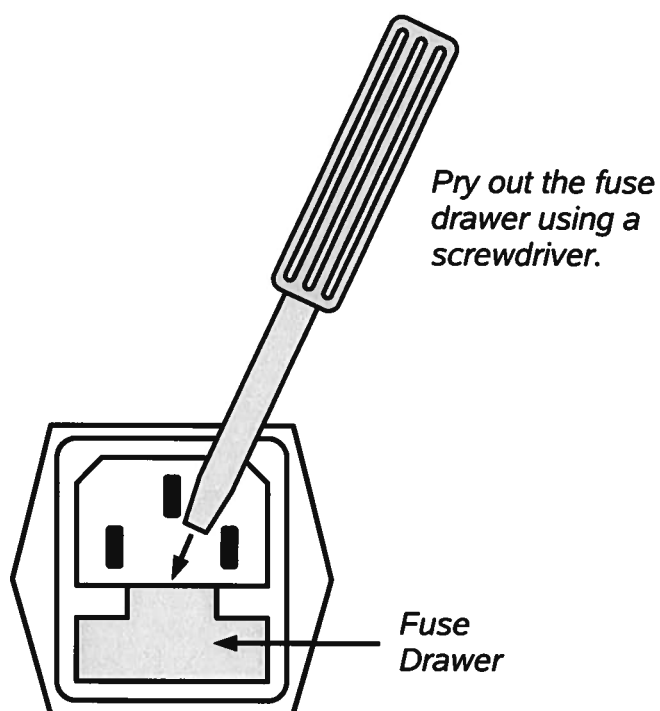

DC FUSE REPLACEMENT

The DC fuses may be replaced by inserting the tip of a flat-head screwdriver into the fuse holder slot, and rotating the slot counter-clockwise. The fuse and its carrier will then pop out.

FUSE RATINGS

The following table lists the required fuses:

| Fuses | Nominal Mains Voltage | Rating | Case Size | Recommended Replacement Part | |
|-------------|-----------------------|------------------------|-----------|------------------------------|-----------------------|
| | | | | Littelfuse Part Number | Digi-Key Stock Number |
| #1, #2 (AC) | 100-240V | 0.5A, 250V, Time-Delay | 5×20 mm | 0218.500HXP | F2416-ND |
| #3 (DC) | N/A | 0.8A, 250V, Time-Delay | 5×20 mm | 0218.800HXP | F2418-ND |
| #4 (DC) | N/A | 0.5A, 250V, Time-Delay | 5×20 mm | 0218.500HXP | F2416-ND |

The recommended fuse manufacturer is Littelfuse (<http://www.littelfuse.com>).

Replacement fuses may be easily obtained from Digi-Key (<http://www.digikey.com>) and other distributors.

FRONT PANEL CONTROLS

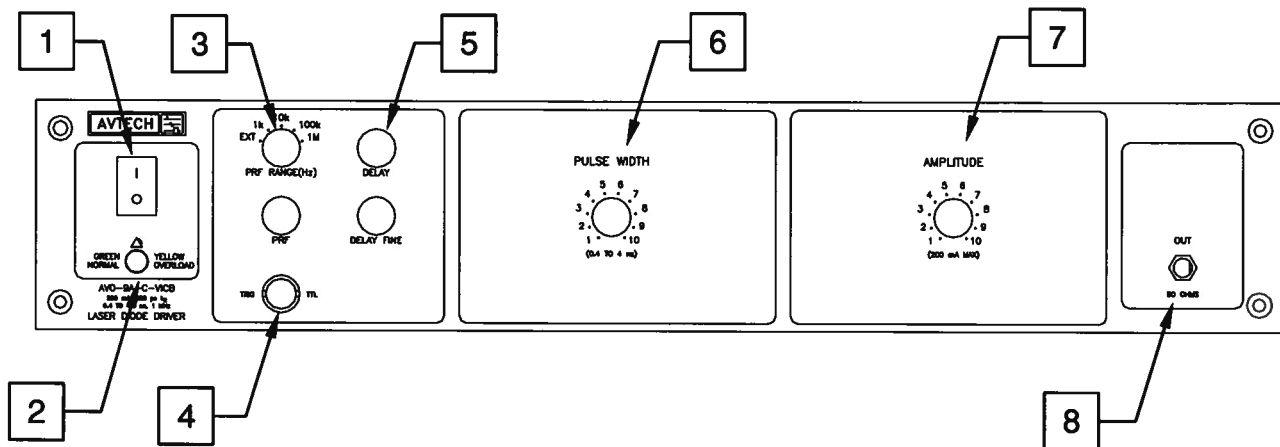

- 1) **POWER Switch**. This is the main power switch. When turning the instrument on, there may be a delay of several seconds before the instrument appears to respond.
- 2) **OVERLOAD Indicator**. When the instrument is powered, this indicator is normally green, indicating normal operation. If this indicator is yellow, an internal automatic overload protection circuit has been tripped. If the unit is overloaded (by operating at an exceedingly high duty cycle or by operating into a very low impedance), the protective circuit will disable the output of the instrument and turn the indicator light yellow. The light will stay yellow (i.e. output disabled) for about 5 seconds after which the instrument will attempt to re-enable the output (i.e. light green) for about 1 second. If the overload condition persists, the output will be disabled again (i.e. light yellow) for another 5 seconds. If the overload condition has been removed, the instrument will resume normal operation.

This overload indicator may flash yellow briefly at start-up. This is not a cause for concern.

- 3) **PRF Range Switch**. This switch sets the pulse repetition frequency (PRF) range of the internal oscillator. The marked value of each position is the upper limit of the 10:1 range, approximately. The vernier dial directly below the switch varies the PRF within the set range.

If this switch is set to the "EXT" position, the instrument is triggered by a signal applied to the TRIG connector, rather than by the internal oscillator.

- 4) **TRIG Connector**. When the PRF Range Switch is set to "EXT", the instrument is triggered by a TTL pulse applied to this connector. The pulse must be at least 50 ns wide.

When the PRF Range Switch is set to one of the four internal oscillator ranges, this connector is an output, which supplies a 2V, 200 ns wide pulse for each trigger

event. This output may be used to trigger oscilloscopes or other equipment.

- 5) Delay Controls. When the PRF Range Switch is set to one of the four internal oscillator ranges, the main output is advanced or delayed relative to the TRIG output pulse (item 3). The delay is variable up to 200 ns, approximately, using the DELAY and DELAY FINE dials.
- 6) Pulse Width Control. This dial controls the pulse width.
- 7) Amplitude Control. This dial controls the amplitude.
- 8) OUT Connector. This SMA connector is connected to the output module, when the output module is used to drive a diode load. If the output module is not used, this output will generate up to 13V into a load impedances of 50Ω. (NOTE: when the output module is not used, this output *requires* a 50Ω load to function properly).

REAR PANEL CONTROLS

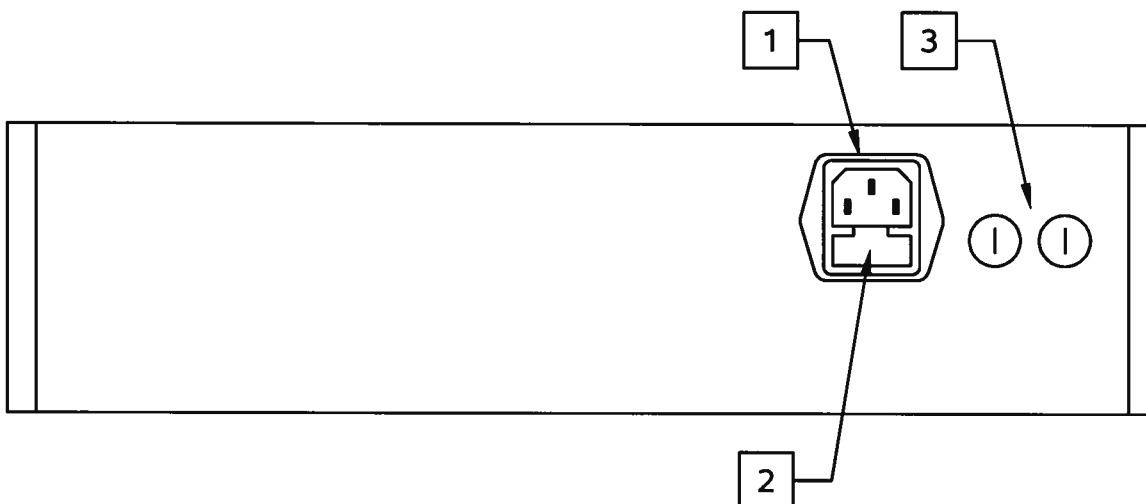

1. **AC POWER INPUT.** An IEC-320 C14 three-pronged recessed male socket is provided on the back panel for AC power connection to the instrument. One end of the detachable power cord that is supplied with the instrument plugs into this socket.
2. **AC FUSE DRAWER.** The two fuses that protect the AC input are located in this drawer. Please see the “FUSES” section of this manual for more information.
3. **DC FUSES.** These two fuses protect the internal DC power supplies. Please see the “FUSES” sections of this manual for more information.

GENERAL INFORMATION

MINIMAL TEST ARRANGEMENT - WITHOUT OUTPUT MODULE

The AVO-9A-C-AK1-P-P2-VICB-CSA can be tested initially without the supplied output module. If the output module is not used, the mainframe output generates 0 to +13V into a 50 Ohm load, as illustrated below:

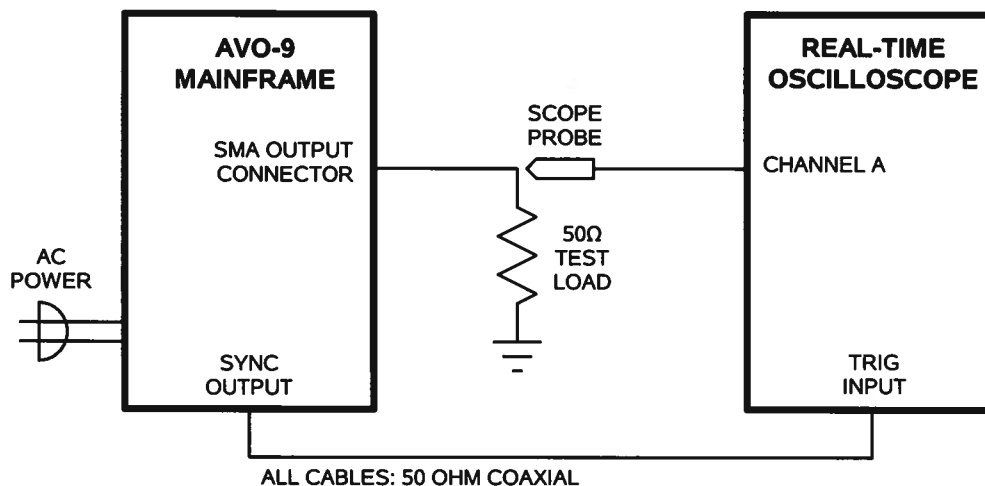

Since the AVO-9A-C-AK1-P-P2-VICB-CSA can generate pulses with rise times as low as 200 ps, it may be necessary to use a sampling oscilloscope, rather than a real-time oscilloscope. In this case, the test arrangement should be altered as shown below:

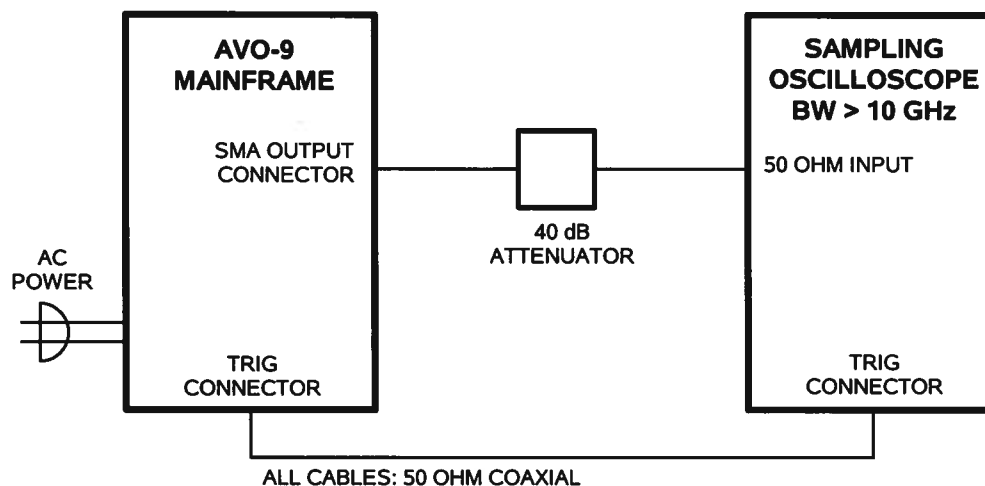

Since most sampling oscilloscopes have limited input amplitude ranges, attenuators are required.

When the output module is not used, a 50 Ohm load impedance is *required* for proper test operation.

NORMAL TEST ARRANGEMENT

To fully test the instrument, and for normal operation, the output module must be connected as shown below:

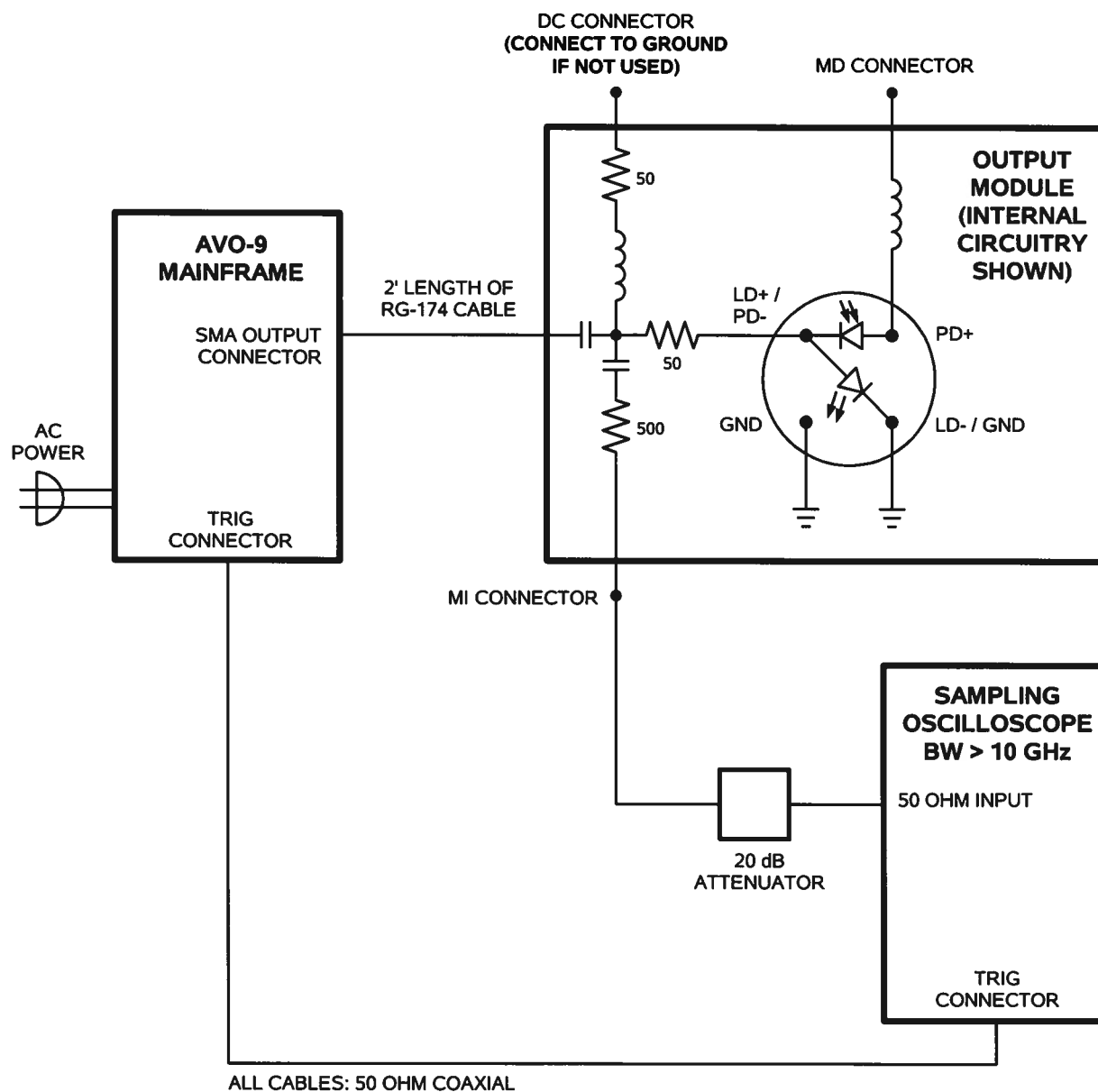

The diode load is inserted into the socket on the output module. The AVX-S1 output module supplied with the AVO-9A-C-AK1-P-P2-VICB-CSA is specifically designed to accommodate 4-pin 5.6mm diodes with the pinout illustrated below (for example, the ULM Photonics ULM850-02-TT-HSMAPP, ULM850-02-TT-HSMAOP, ULM850-02-TT-H56BPP, ULM850-02-TT-H56BOP, and ULM850-02-TT-H56FOP diodes):

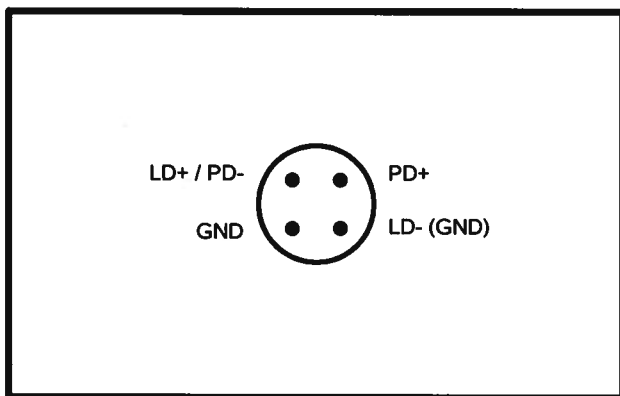

AVX-S1 OUTPUT MODULE, SOCKET VIEW

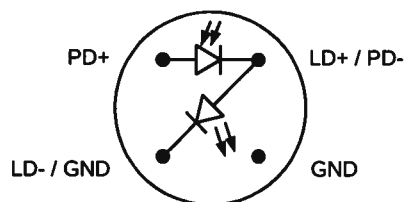

MATCHING USER-SUPPLIED
DIODE PACKAGE
(BOTTOM VIEW).
5.6 mm PACKAGE.

NOTE: Trim the diode leads to **no longer than 1.0 cm in length**. If the leads are longer than that, they may cause an internal short circuit in the output module, which may cause damage to the diode and the output module.

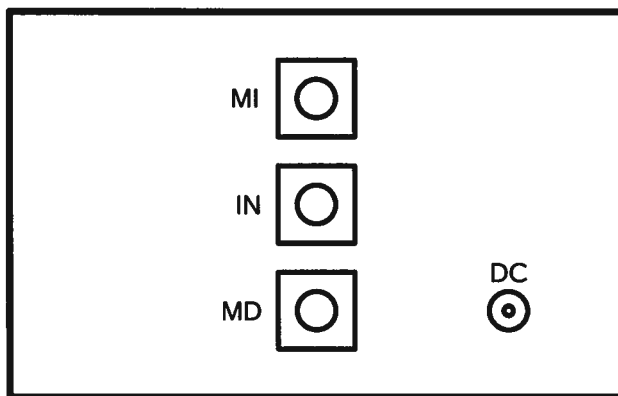

AVX-S1 OUTPUT MODULE, CONNECTOR VIEW

An oscilloscope may be used to monitor the MI and MD outputs, the locations of which are shown in the figure above. A forward DC bias may be applied to the laser diode by connecting a DC potential of 0 to +5 Volts to the DC solder terminal. The application of a small forward bias often yields a more ideal diode current waveform (as observed on the MI port). **Note that the DC port must be shorted to ground if a bias is not applied.**

The MD output is filtered, and is only useful for observing DC conditions.

AMPLITUDE CONTROL

When using the output module, the pulse current through the diode load is given by:

$$I_{\text{DIODE}} = (V_{\text{SET}} - V_{\text{DIODE}}) / (50\Omega + R_{\text{DIODE}})$$

where V_{SET} is the amplitude setting on the mainframe (between 0 and +13V), V_{DIODE} is the forward voltage drop across the diode (typically 2-3V), and R_{DIODE} is the resistor internal to the laser diode (normally approximately 0Ω). The 50Ω resistance is built into the AVX-S1-INFA output module.

The AVO-9A-C-AK1-P-P2-VICB-CSA can deliver up to 13V into a total resistance (diode resistance + output module resistance) of 50 Ohms. This means that if your diode voltage is 3V, then you can obtain up to $(13\text{V} - 3\text{V}) / 50\text{ Ohms} = 200\text{ mA}$ of current, approximately.

BASIC PULSE CONTROL

This instrument can be triggered by its own internal clock or by an external TTL trigger signal. When triggered internally, two mainframe output channels respond to the trigger: OUT and SYNC.

- OUT. This is the main output. The maximum output voltage is 13V.
- TRIG. The TRIG pulse is a fixed-width TTL-level reference pulse used to trigger oscilloscopes or other measurement systems.

These pulses are illustrated below:

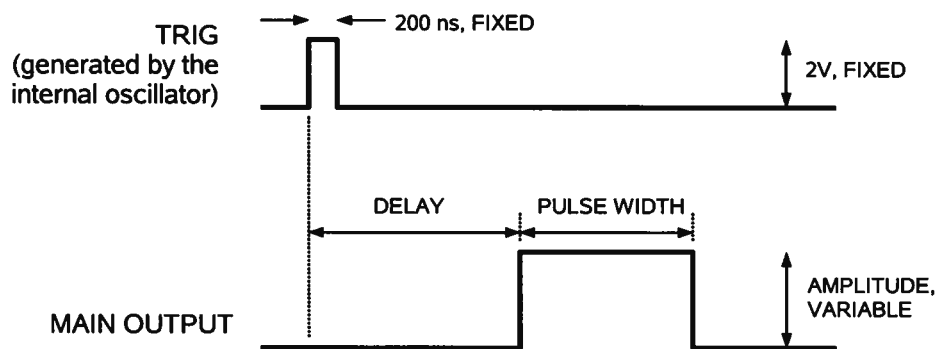

Figure A

When triggered externally, the TRIG connector acts as an input. The delay controls do not function in this mode.

PULSE WIDTH / AMPLITUDE INTERACTION

The pulse width and delay of the output pulse may vary slightly with the amplitude setting, particularly at lower amplitudes. For some demanding applications, it may be desirable to use external attenuators in conjunction with the AVO-9A-C-AK1-P-P2-VICB-CSA, instead of generating a low-amplitude pulse directly.

PROTECTING YOUR INSTRUMENT

DO NOT EXCEED 1 MHz

The output stage may be damaged if triggered by an external signal at a pulse repetition frequency greater than 1 MHz.

USE A 50Ω LOAD

The mainframe output stage may be damaged if the output is not terminated into the output module or a 50Ω dummy load.

INSTALL THE DIODE CORRECTLY

NOTE: Trim the diode leads to **no longer than 1.0 cm in length**. If the leads are longer than that, they may cause an internal short circuit in the output module, which may cause damage to the diode and the output module.

MECHANICAL INFORMATION

TOP COVER REMOVAL

If necessary, the interior of the instrument may be accessed by removing the four Phillips screws on the top panel. With the four screws removed, the top cover may be slid back (and off).

 Always disconnect the power cord and allow the instrument to sit unpowered for 10 minutes before opening the instrument. This will allow any internal stored charge to discharge.

There are no user-adjustable internal circuits. For repairs other than fuse replacement, please contact Avtech (info@avtechpulse.com) to arrange for the instrument to be returned to the factory for repair. Service is to be performed solely by qualified service personnel.

 Caution: High voltages are present inside the instrument during normal operation. Do not operate the instrument with the cover removed.

RACK MOUNTING

A rack mounting kit is available. The -R5 rack mount kit may be installed after first removing the one Phillips screw on the side panel adjacent to the front handle.

ELECTROMAGNETIC INTERFERENCE

To prevent electromagnetic interference with other equipment, all used outputs should be connected to shielded loads using shielded coaxial cables. Unused outputs should be terminated with shielded coaxial terminators or with shielded coaxial dust caps, to prevent unintentional electromagnetic radiation. All cords and cables should be less than 3m in length.

MAINTENANCE

REGULAR MAINTENANCE

This instrument does not require any regular maintenance.

On occasion, one or more of the four rear-panel fuses may require replacement. All fuses can be accessed from the rear panel. See the “FUSES” section for details.

CLEANING

If desired, the interior of the instrument may be cleaned using compressed air to dislodge any accumulated dust. (See the “TOP COVER REMOVAL” section for instructions on accessing the interior.) No other cleaning is recommended.

PCB 158K - LOW VOLTAGE POWER SUPPLY, 1/3

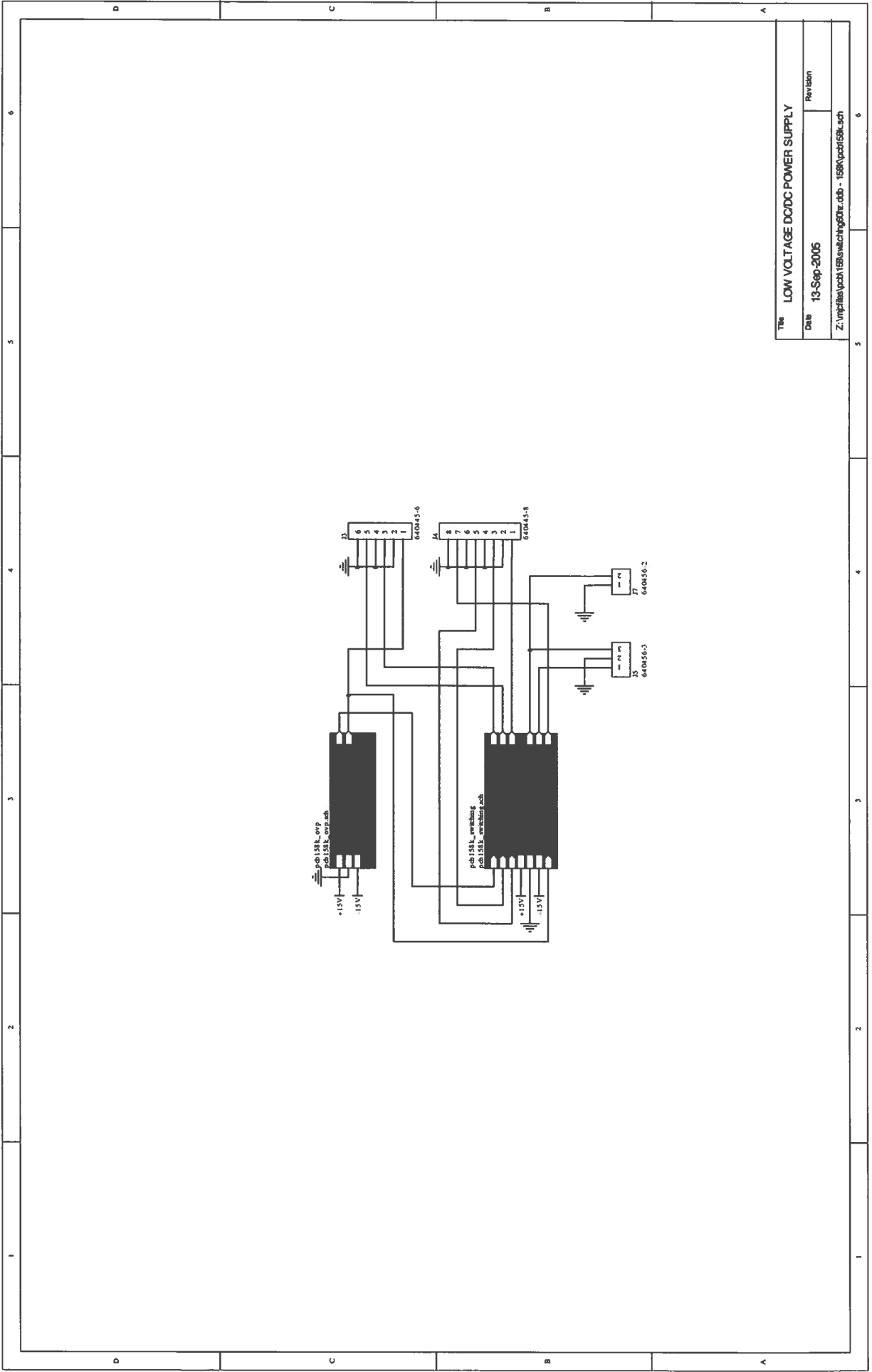

| | | |
|---|-------------|--------------------------------|
| Title | | LOW VOLTAGE DC/DC POWER SUPPLY |
| Date | 13-Sep-2005 | Revision |
| Z:\mp\files\pcb\158\switching01r.ddb - 158k\pcb158k.sch | | |

PCB 158K - LOW VOLTAGE POWER SUPPLY, 2/3

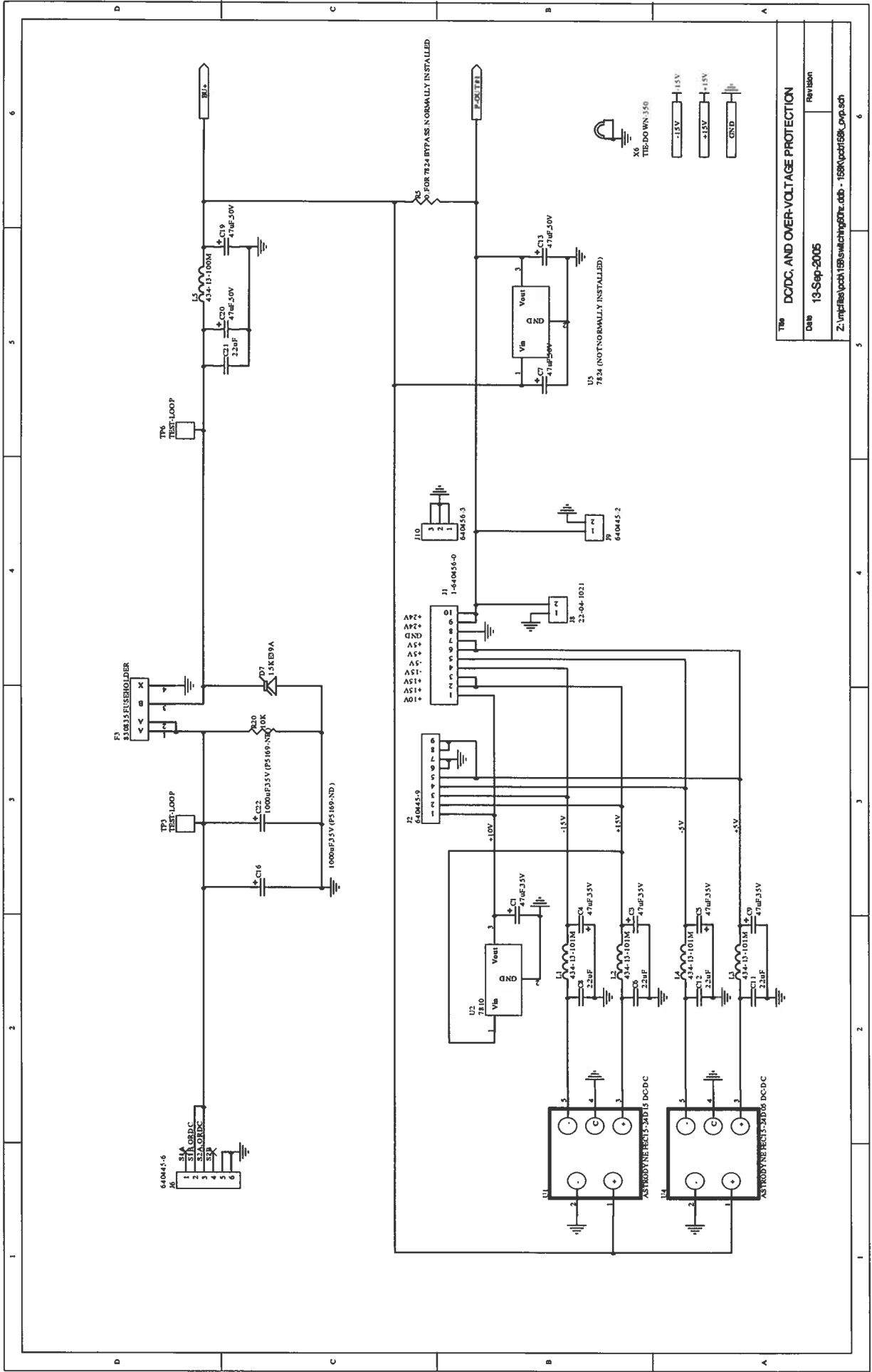

PCB 158K - LOW VOLTAGE POWER SUPPLY, 3/3

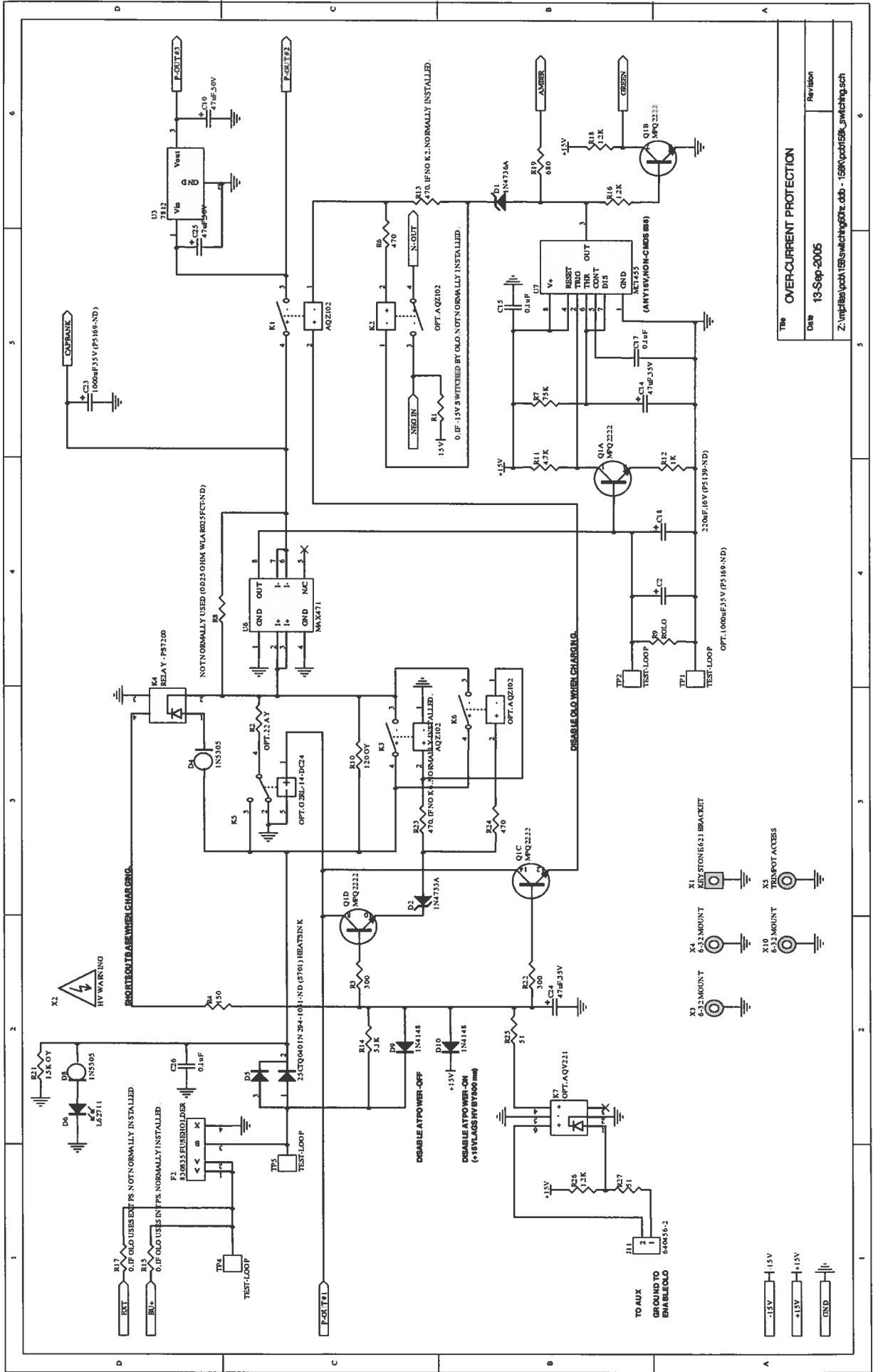

| | |
|---|-------------|
| The OVERCURRENT PROTECTION | |
| Date | 13-Sep-2005 |
| Z:\mpfiles\pcb158k\switching\pcb_158k\pcb158k_switching.sch | |

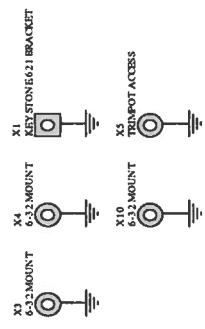
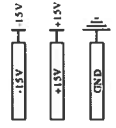

Dec 7/05