



# AVTECH ELECTROSYSTEMS LTD.

NANOSECOND WAVEFORM ELECTRONICS  
SINCE 1975

P.O. BOX 265  
OGDENSBURG, NY  
U.S.A. 13669-0265  
TEL: (315) 472-5270  
FAX: (613) 226-2802

TEL: 1-800-265-6681  
FAX: 1-800-561-1970

e-mail: [info@avtechpulse.com](mailto:info@avtechpulse.com)  
<http://www.avtechpulse.com/>

BOX 5120, LCD MERIVALE  
OTTAWA, ONTARIO  
CANADA K2C 3H4  
TEL: (613) 226-5772  
FAX: (613) 226-2802

## INSTRUCTIONS

MODEL AV-110H-PS

0 to  $\pm 2$  VOLTS IN,

0 to  $\pm 50$  VOLTS OUT, TO  $R_L \geq 15 \text{ k}\Omega$

1 MHz VARIABLE-GAIN LINEAR AMPLIFIER

SERIAL NUMBER: \_\_\_\_\_

### WARRANTY

Avtech Electrosystems Ltd. warrants products of its manufacture to be free from defects in material and workmanship under conditions of normal use. If, within one year after delivery to the original owner, and after prepaid return by the original owner, this Avtech product is found to be defective, Avtech shall at its option repair or replace said defective item. This warranty does not apply to units which have been disassembled, modified or subjected to conditions exceeding the applicable specifications or ratings. This warranty is the extent of the obligation assumed by Avtech with respect to this product and no other warranty or guarantee is either expressed or implied.

### TECHNICAL SUPPORT

Phone: 613-226-5772 or 1-800-265-6681

Fax: 613-226-2802 or 1-800-561-1970

E-mail: [info@avtechpulse.com](mailto:info@avtechpulse.com)

World Wide Web: <http://www.avtechpulse.com>

## TABLE OF CONTENTS

<b>WARRANTY.....</b>	<b>2</b>
<b>TECHNICAL SUPPORT.....</b>	<b>2</b>
<b>TABLE OF CONTENTS.....</b>	<b>3</b>
<b>INTRODUCTION.....</b>	<b>4</b>
<b>AVAILABLE OPTIONS.....</b>	<b>4</b>
<b>SPECIFICATIONS.....</b>	<b>5</b>
<b>INSTALLATION.....</b>	<b>6</b>
<b>VISUAL CHECK.....</b>	<b>6</b>
<b>PLUGGING IN THE INSTRUMENT.....</b>	<b>6</b>
<b>FRONT PANEL CONTROLS.....</b>	<b>8</b>
<b>REAR PANEL CONTROLS.....</b>	<b>10</b>
<b>GENERAL INFORMATION.....</b>	<b>11</b>
<b>BASIC CONTROL.....</b>	<b>11</b>
<b>CABLING.....</b>	<b>11</b>
<b>TOP COVER REMOVAL.....</b>	<b>11</b>
<b>OPERATIONAL CHECK.....</b>	<b>12</b>
<b>POWER SUPPLY AND FUSE REPLACEMENT.....</b>	<b>14</b>
<b>PERFORMANCE CHECK SHEET.....</b>	<b>16</b>

Manual Reference: T:\instructwordlav-110AV-110H-PS-OS,edition2.sxw.  
Last modified October 23, 2003.  
Copyright © 2003 Avtech Electrosystems Ltd, All Rights Reserved.

## INTRODUCTION

The AV-110H-PS is a variable-gain linear amplifier. The gain may be adjusted from +1 to +25. The input range is 0 to  $\pm 2\text{V}$ , and the output range is 0 to  $\pm 50\text{V}$ . The output can drive load impedances of  $15\text{ k}\Omega$  and higher. The amplifier bandwidth is 1 MHz.

## AVAILABLE OPTIONS

The AV-110H-PS is available with this option:

"-OS" Option: A 0 to  $\pm 25\text{V}$  offset may be added to the output, using a front-panel offset control.

## SPECIFICATIONS

Model:	AV-110H-PS
Output Amp. (max):	$\pm 50$ V
Load impedance:	$\geq 15$ k $\Omega$
Bandwidth (kHz):	0 - 1000
Voltage gain (variable):	x1 to x25
Rise time (for max output):	0.3 $\mu$ s
Output power, max.	0.16 W
Dual channel option <sup>1</sup> :	Yes
DC offset option <sup>2</sup> :	$\pm 25$ V
Connectors:	BNC
Power:	120/240 Volts (switchable) 50-60 Hz
Dimensions:	100 mm x 215 mm x 375 mm (3.9" x 8.5" x 14.8")

- 1) To specify the two channel option add the suffix -D.
- 2) To specify the DC offset option, add the suffix -OS.

## INSTALLATION

### VISUAL CHECK

After unpacking the instrument, examine to ensure that it has not been damaged in shipment. Visually inspect all connectors, knobs, and handles. Confirm that a power cord is with the instrument. If the instrument has been damaged, file a claim immediately with the company that transported the instrument.

### PLUGGING IN THE INSTRUMENT

Examine the rear of the instrument. There will be a male power receptacle, a fuse holder and the edge of the power selector card visible. Confirm that the power selector card is in the correct orientation.

For AC line voltages of 110-120V, the power selector card should be installed so that the "120" marking is visible from the rear of the instrument, as shown below:

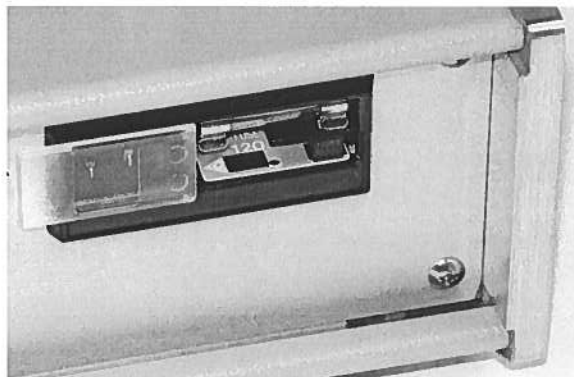

For AC line voltages of 220-240V, the power selector card should be installed so that the "240" marking is visible from the rear of the instrument, as shown below:

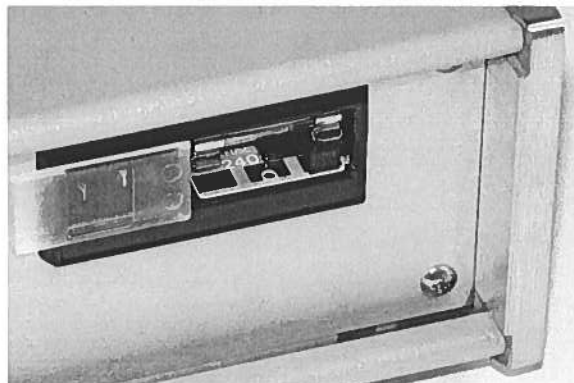



If it is not set for the proper voltage, remove the fuse and then grasp the card with a pair of pliers and remove it. Rotate horizontally through 180 degrees. Reinstall the card and the correct fuse.

In the 120V setting, a 0.5A slow blow fuse is required. In the 240V setting, a 0.25A slow blow fuse is required.



## FRONT PANEL CONTROLS

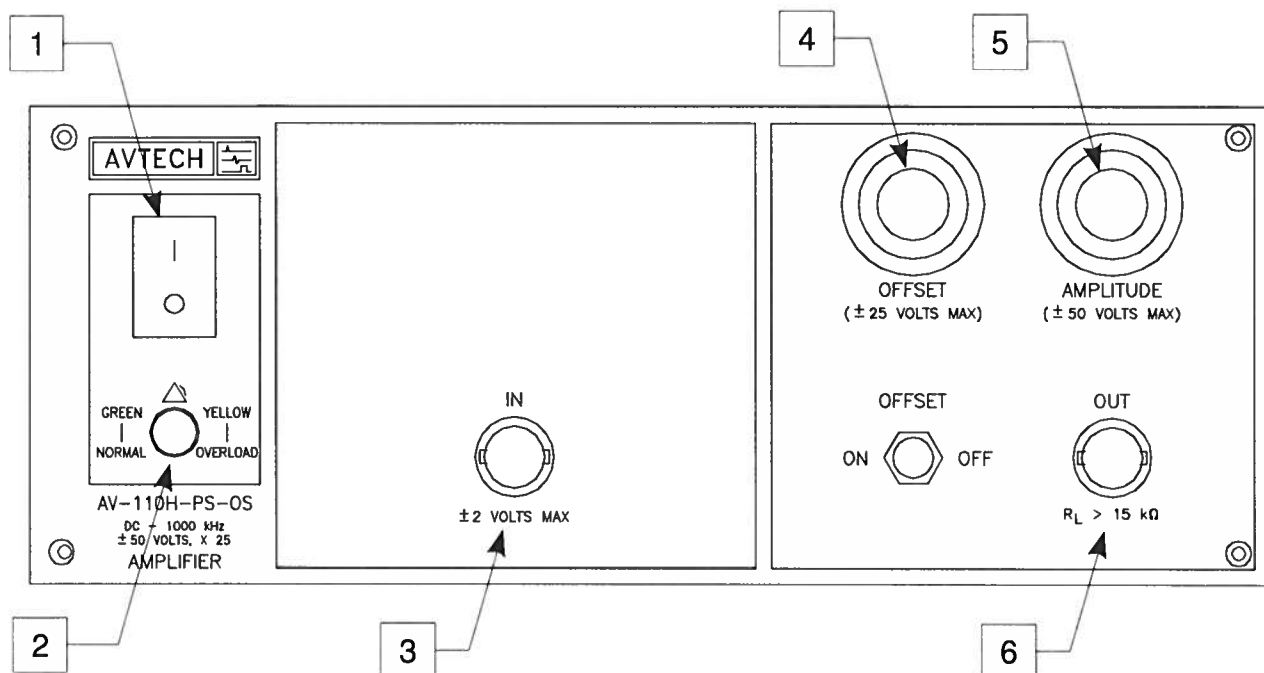

1. **POWER Switch.** This is the main power switch. When turning the instrument on, there may be a delay of several seconds before the instrument appears to respond.
2. **OVERLOAD Indicator.** When the instrument is powered, this indicator is normally green, indicating normal operation. If this indicator is yellow, an internal automatic overload protection circuit has been tripped. If the unit is overloaded (by operating at an exceedingly high duty cycle or by operating into a very low impedance), the protective circuit will disable the output of the instrument and turn the indicator light yellow. The light will stay yellow (i.e. output disabled) for about 5 seconds after which the instrument will attempt to re-enable the output (i.e. light green) for about 1 second. If the overload condition persists, the output will be disabled again (i.e. light yellow) for another 5 seconds. If the overload condition has been removed, the instrument will resume normal operation.

This overload indicator may flash yellow briefly at start-up. This is not a cause for concern.

3. **IN Connector.** The input signal is applied to this BNC connector. The input voltage must not exceed  $\pm 2$  Volts. The input impedance of this input is  $1\text{ k}\Omega$ . (Depending on the length of cable attached to this input, and the source driving it, it may be desirable to add a coaxial 50 Ohm terminator to this input to provide a proper transmission line termination. The Pasternack ([www.pasternack.com](http://www.pasternack.com)) PE6008-50 BNC feed-thru 50 Ohm terminator is suggested for this purpose.)



4. OFFSET Controls. (Optional: -OS option only.) This dial varies the DC offset on the output from 0 to  $\pm 25\text{V}$ . The ON/OFF switch below the dial enables and disables this function.
5. Amplitude Control. This dial controls the amplitude (i.e., the gain).
6. OUT Connector. This is the main output. It can drive loads of  $15\text{ k}\Omega$  and higher.

## REAR PANEL CONTROLS

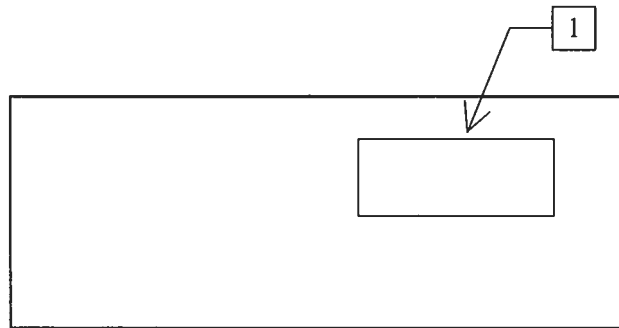

1. AC POWER INPUT. A three-pronged recessed male connector is provided on the back panel for AC power connection to the instrument. Also contained in this assembly is a slow-blow fuse and a removable card that can be removed and repositioned to switch between 120V AC in and 240V AC in.

For AC line voltages of 110-120V, the power selector card should be installed so that the “120” marking is visible from the rear of the instrument.

For AC line voltages of 220-240V, the power selector card should be installed so that the “240” marking is visible from the rear of the instrument.

If it is not set for the proper voltage, remove the fuse and then grasp the card with a pair of pliers and remove it. Rotate horizontally through 180 degrees. Reinstall the card and the correct fuse.

In the 120V setting, a 0.5A slow blow fuse is required. In the 240V setting, a 0.25A slow blow fuse is required. See the “Installation” section for more details.

## GENERAL INFORMATION

### BASIC CONTROL

The AV-110H-PS is a DC-1 MHz variable-gain linear amplifier. The gain is variable from +1 to +25, and is adjusted by rotating the "Amplitude" control.

The required voltage input signal is applied at the "IN" connector.

This mode is illustrated below:

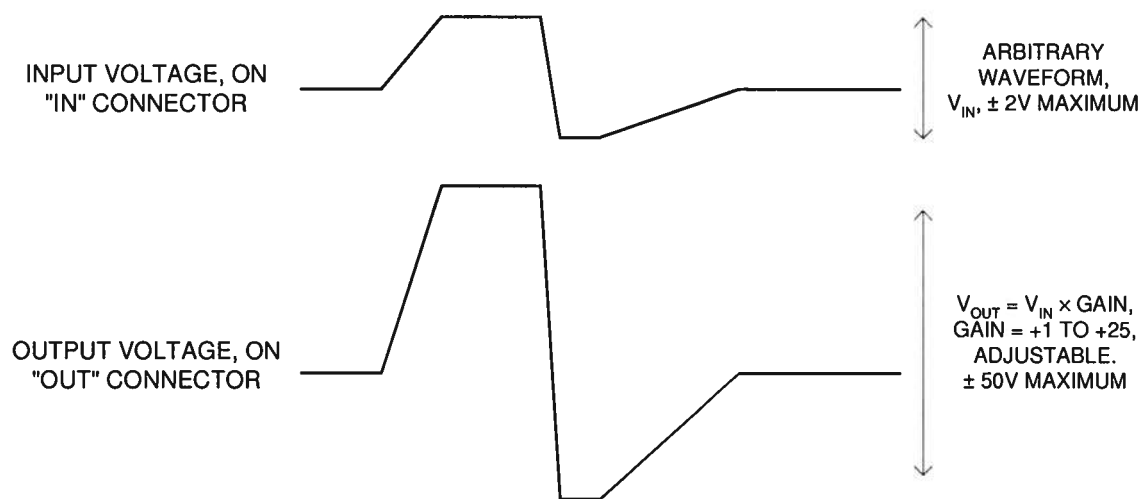

### CABLING

The output must be terminated with a load impedance of 15k $\Omega$  (or higher). Fifty-ohm coaxial cable may be used to connect the output to the load, but the length of cable between the output connector and the load should be less than 24" in order to avoid distortion of the waveform.

### TOP COVER REMOVAL

The top cover of the instrument may be removed by removing the four Phillips screws on the top panel. With these four screws removed, the top panel may be slid off by pulling it towards the rear.

The instrument should not be accessed internally unless it has been turned off for ten minutes, to allow all internal capacitors to discharge.

## OPERATIONAL CHECK

This section describes a sequence to confirm the basic operation of the instrument. It should be performed after receiving the instrument. It is a useful learning exercise as well.

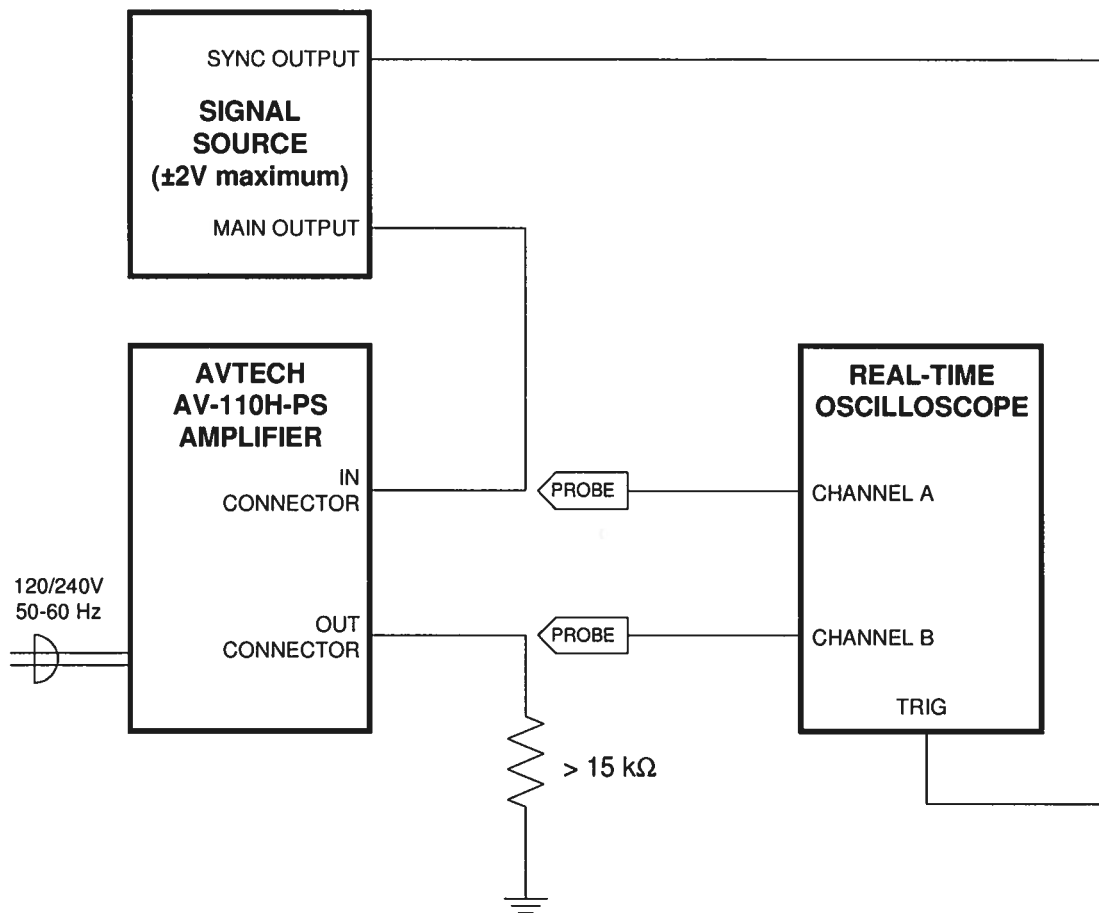

*Basic Test Arrangement*

- 1) Connect a 15 kΩ, 1/2W test load between the OUT connector and ground. Confirm that the oscilloscope and the test load are rated for ±50 Volt operation.
- 2) Set the signal generator to produce a ±2V, 25 kHz waveform. Connect a cable from the SYNC connector of the signal generator to the TRIG input of an oscilloscope. Set the oscilloscope to trigger externally. Connect the main output of the signal generator to the input of the amplifier.
- 3) Connect one oscilloscope probe (channel A) to the output of the signal generator. Set the Channel A vertical scale to 1 V/div.

- 4) Connect one oscilloscope probe (channel B) to the 15 k $\Omega$  load. On the oscilloscope, set the channel A vertical scale to 20 V/div, and the horizontal scale to 20 us/div.
- 5) Set the gain control to minimum (0.0). Turn on the amplifier and the signal generator.
- 6) Channel A should show a  $\pm 2$ V, 25 kHz waveform from the signal generator. Rotate the gain control to its maximum setting. The Channel B waveform should increase to  $\pm 50$ V, and have a shape similar to that of the Channel A waveform.
- 7) This completes the operational check.

If additional assistance is required:

Tel: (613) 226-5772  
Fax: (613) 226-2802  
Email: [info@avtechpulse.com](mailto:info@avtechpulse.com)

## POWER SUPPLY AND FUSE REPLACEMENT

This instrument has three main fuses, plus two spares. One, which protects the AC input, is located in the rear-panel power entry module, as described in the “Rear Panel Controls” section of this manual. If the power appears to have failed, check the AC fuse first.

The other two fuses (plus two spares) are located on the internal DC power supply, as shown below:

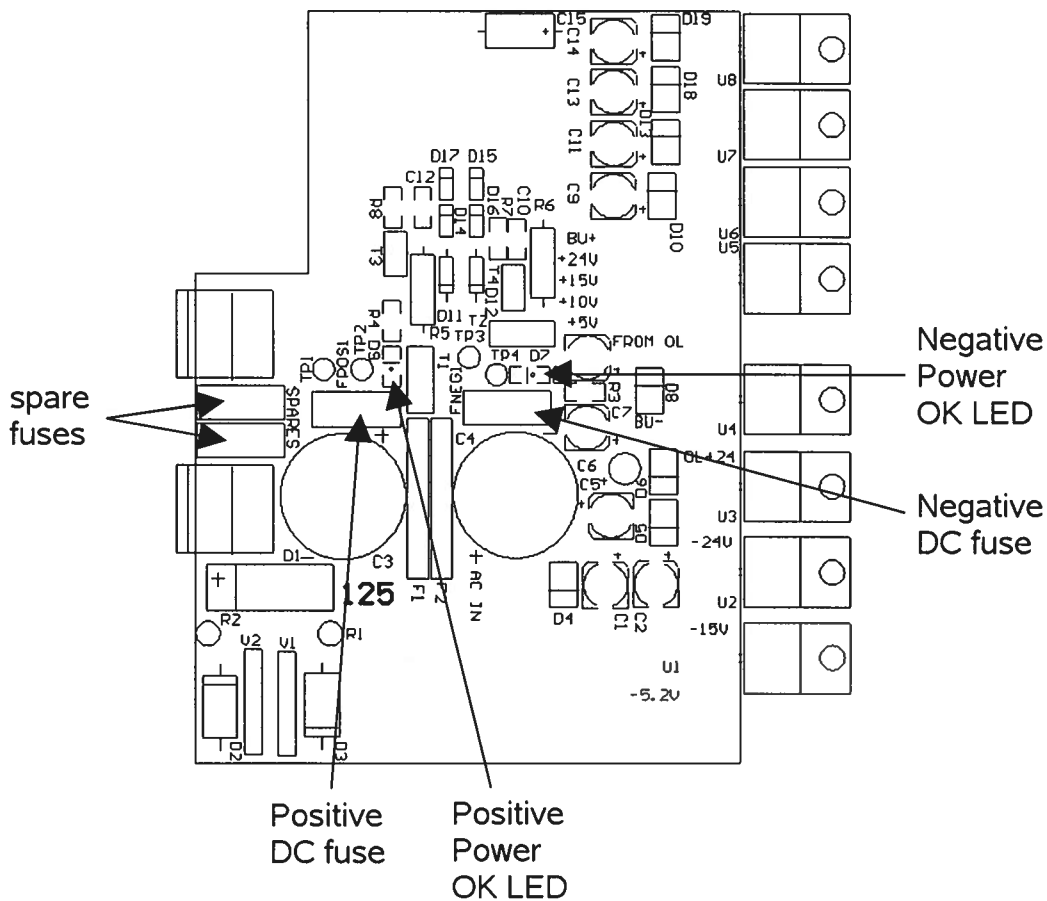

The positive fuse and one of the spare fuses on this circuit board are 1A slow-blow fuses, Littlefuse part number R452001. (This fuse can be ordered from Digikey, [www.digikey.com](http://www.digikey.com). The Digikey part number is F1343CT-ND). The negative fuse and the second spare fuse are 0.5A slow-blow fuses (Littlefuse R452.500, Digikey part number F1341CT-ND).

If you suspect that the DC fuses are blown, follow this procedure:

1. Remove the top cover, by removing the four Phillips screws on the top cover and then sliding the cover back and off.

2. Locate the two "Power OK" LEDs on the power supply circuit board, as illustrated above.
3. Turn on the instrument.
4. Observe the "Power OK" LEDs. If the fuses are not blown, the two LEDs will be lit (bright red). If one of the LEDs is not lit, the fuse next to it has blown.
5. Turn off the instrument.
6. If a fuse is blown, use needle-nose pliers to remove the blown fuse from its surface-mount holder.
7. Replace the fuse. (Spare 1 Amp and 0.5 Amp fuses are provided on the circuit board. They may be transferred to the active fuse locations using needle-nose pliers.)

Oct. 23 / 03